

V1.1

3DMakerpro

store.3dmakerpro.com

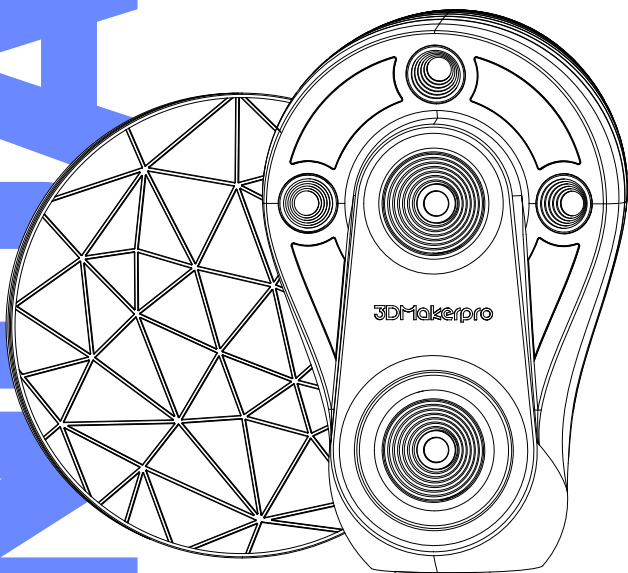

3DMakerpro

f @3DMakerProCares

@official3DMakerPro

@3DMakerPro

https://store.3dmakerpro.com/

service@3dmakerpro.com

JimuMeta

@JimuMeta @JimuMeta

https://www.jimumeta.com/

service@jimumeta.com



WHALE

Hardware Connection **P1**

Packing List **P3**

Computer Requirements



Minimum

Intel Core i5 8th, 16GB RAM,
MX250 GPU with 2GB VRAM

Recommended

Intel Core i7 8th, 16GB RAM,
NVDIA1060 GPU with 4GB VRAM

P1

HARDWARE CONNECTION

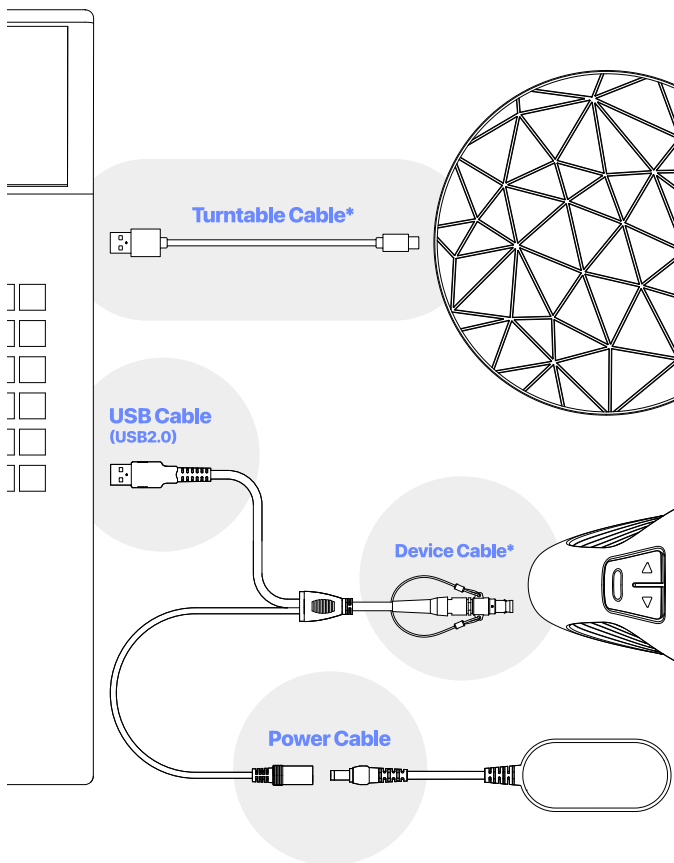

One end of the device is plugged into the navigation plug, and the other side is plugged into the power cord and computer USB 2.0 or above port respectively.

P2

* Device Cable

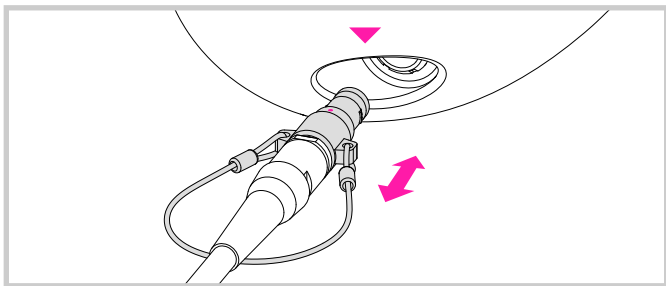

Insert the power plug at the device end by aligning the raised point with the interface dot mark.

Pull the cord on the plug when pulling it out.

* Turntable Cable

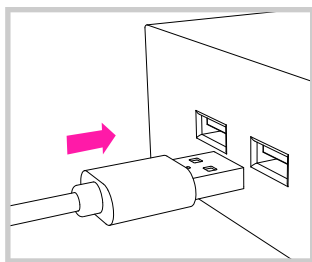
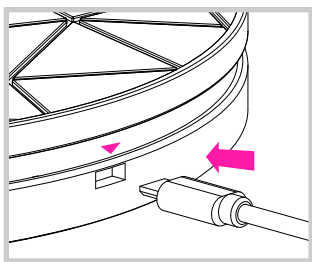

The turntable power cord can be plugged into the computer through usb power supply, or use the phone charger for its power supply.

P3

PACKING LIST

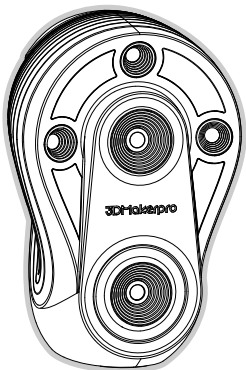

Host

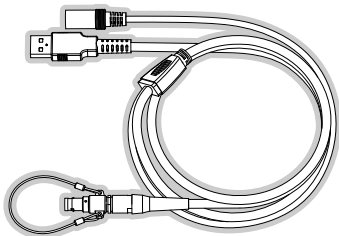

Device Cable



Turntable Cable*

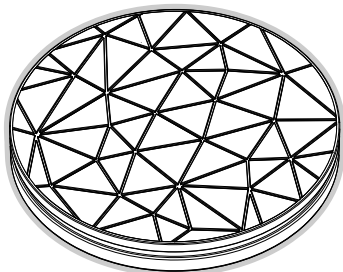

Turntable*

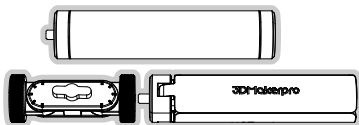

Tripod*



USB Drive

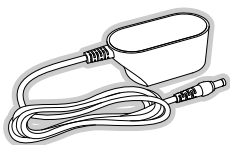

Power Supply

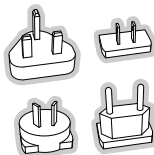

Changeover Plug



Manual

* Not included in the standard package.



To prevent antivirus software from blocking the driver, please uninstall the antivirus software.