

CLEANI with Tank^{Plus}

High-Volume Washer for Dental 3D Printing



Ideal for High-Volume Production

Thanks to its high capacity and fast washing cycle, Tank Plus makes CLEANI ideal for demanding digital dentistry workflows, accommodating 8 full arches efficiently.



Made to Match Our New 3D Printing Solution Plus

With Tank Plus, our alcohol washer becomes the perfect fit for our new 3D Printing Solution Plus - wash up to 8 full-arch applications in one go to match the high production that SOL Plus and CURIE Plus deliver perfectly.



Enjoy a Short 5-Min Wash Cycle

Complete an entire washing cycle in just 5 minutes. With Tank Plus, enjoy the advantage of swiftly washing high-volume 3D printed applications in record time.

CLEANI with Dual Tanks

Dual Tank Washer for Dental 3D Printing



Perfect for Biocompatible Workflows - Up to 4 Full-Arches at Once

The versatile two-stage cleaning process guarantees a safe and hygienic wash for your 3D-printed applications, such as crowns, bridges, splints, surgical guides, denture bases, teeth, and models, among many others. It is ideal for both biocompatible and non-biocompatible rigorous workflows.



2-in-1: Clean Both Your Build Platform and Applications

Save time and up to 50% alcohol consumption with Dual Tanks. Accommodate a wide range of build platforms with the 3D prints still attached for a simultaneous wash process.



6 Minutes, 2 Cycles

Remove up to 90% of excess resin during the **dirty wash** and employ the second tank for a **clean wash** ensuring the removal of all remaining resin particles.



A Seamless Move from Printer to Washer

CLEANI with Dual Tanks & CLEANI with Tank Plus



Perfectly Sized for
Dental Practices



No guesswork:
Hydrometer for Clean
Alcohol in the Tank



3 Pre-set cycles:
3, 5, & 10 mins.



Vortex motion with
gentle vibrations to
reduce damage risk



CLEANI with Tank^{Plus} & CLEANI with Dual Tanks

Technical Specifications

CLEANI with Tank Plus

CLEANI with Dual Tanks

Dimensions

 25 (W) x 24 (D) x 31 (H) cm
9.8 (W) x 9.4 (D) x 12.2 (H) in

Weight

 2.7 kg
6 lbs

Dimensions

 23 (W) x 23 (D) x 33 (H) cm
9.1 (W) x 9.1 (D) x 13 (H) in

Weight

 4.2 kg
9.3 lbs

Tank Size

 25 (W) x 24 (D) x 20 (H) cm
9.8 (W) x 9.4 (D) x 7.9 (H) in

Tank Volume

 7 L

Tank Size

 11 (W) x 23 (D) x 23 (H) cm
4.3 (W) x 9.1 (D) x 9.1 (H) in

Tank Volume

 4 L per tank

Base Size

23 (W) x 23 (D) x 12 (H) cm
9.1 (W) x 9.1 (D) x 4.7 (H) in

Time Control

3, 5, or 10 minutes

Rated Power

48 W

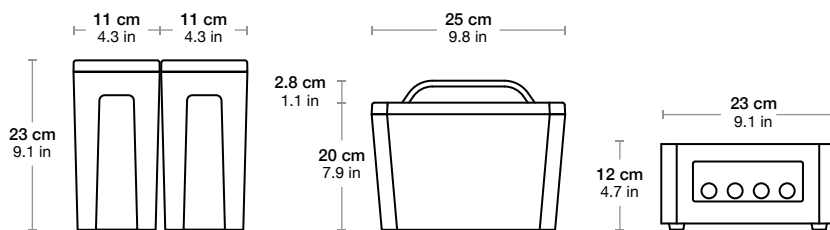

Power Input

100-240VAC, 50-60Hz

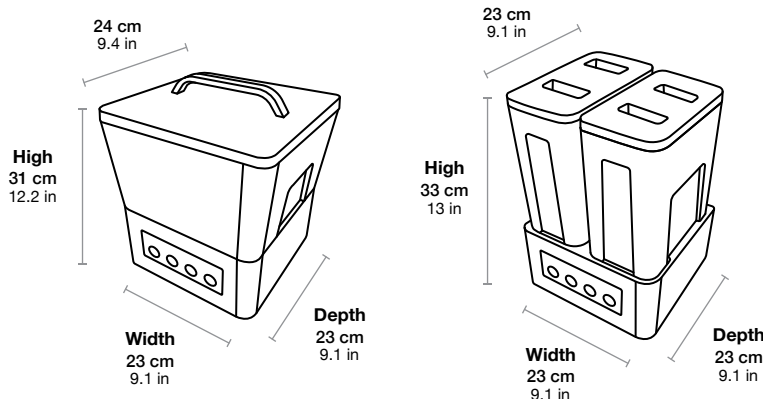

CLEANI with Tank Plus PACKAGE CONTENTS

- | | |
|-----------------|-----------------|
| 1 x Base | 1 x Hydrometer |
| 1 x Tank | 1 x Power Cable |
| 1 x Lid | 1 x AC Adapter |
| 1 x Mesh Basket | |



CLEANI with Dual Tanks PACKAGE CONTENTS

- | | | |
|----------|-----------------|-----------------|
| 1 x Base | 2 x Jig | 2 x Hydrometer |
| 2 x Tank | 2 x Bar | 1 x Power Cable |
| 2 x Lid | 2 x Mesh Basket | 1 x AC Adapter |

Visit ackuretta.com to learn more
For sales inquiries, contact sales@ackuretta.com