





CLEANI

with Tank^{Plus}

Technical Specifications

 **Time Control**
3, 5, or 10 minutes

 **Tank Size**
25 (W) x 24 (D) x 20 (H) cm
9.8 (W) x 9.4 (D) x 7.9 (H) in

 **Rated Power**
48 W

 **Dimensions**
25 (W) x 24 (D) x 31 (H) cm
9.8 (W) x 9.4 (D) x 12.2 (H) in

 **Base Size**
23 (W) x 23 (D) x 12 (H) cm
9.1 (W) x 9.1 (D) x 4.7 (H) in

 **Power Input**
100-240VAC, 50-60Hz

 **Weight**
2.7 kg
6 lbs

 **Tank Volume**
7 L

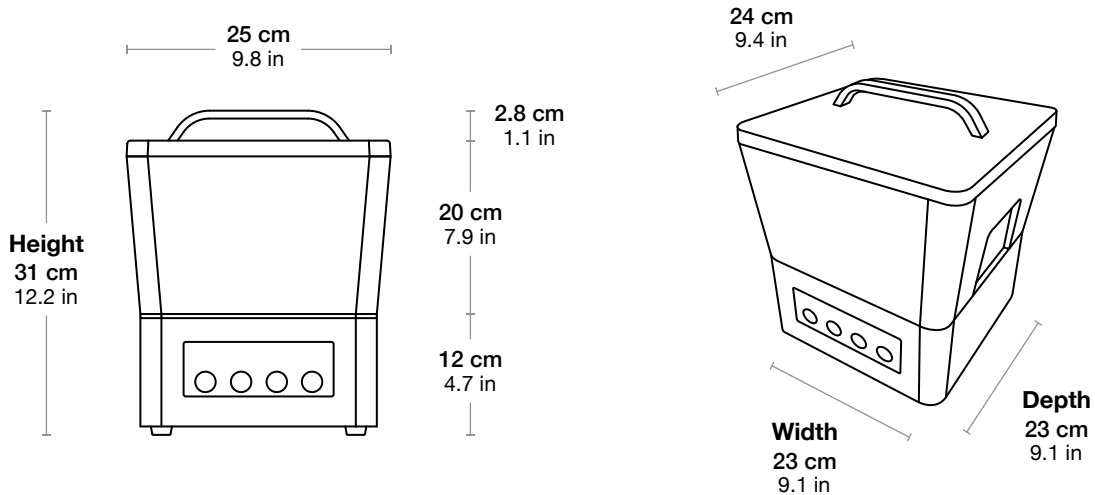

Visit ackuretta.com to learn more
 For sales inquiries, contact sales@ackuretta.com