

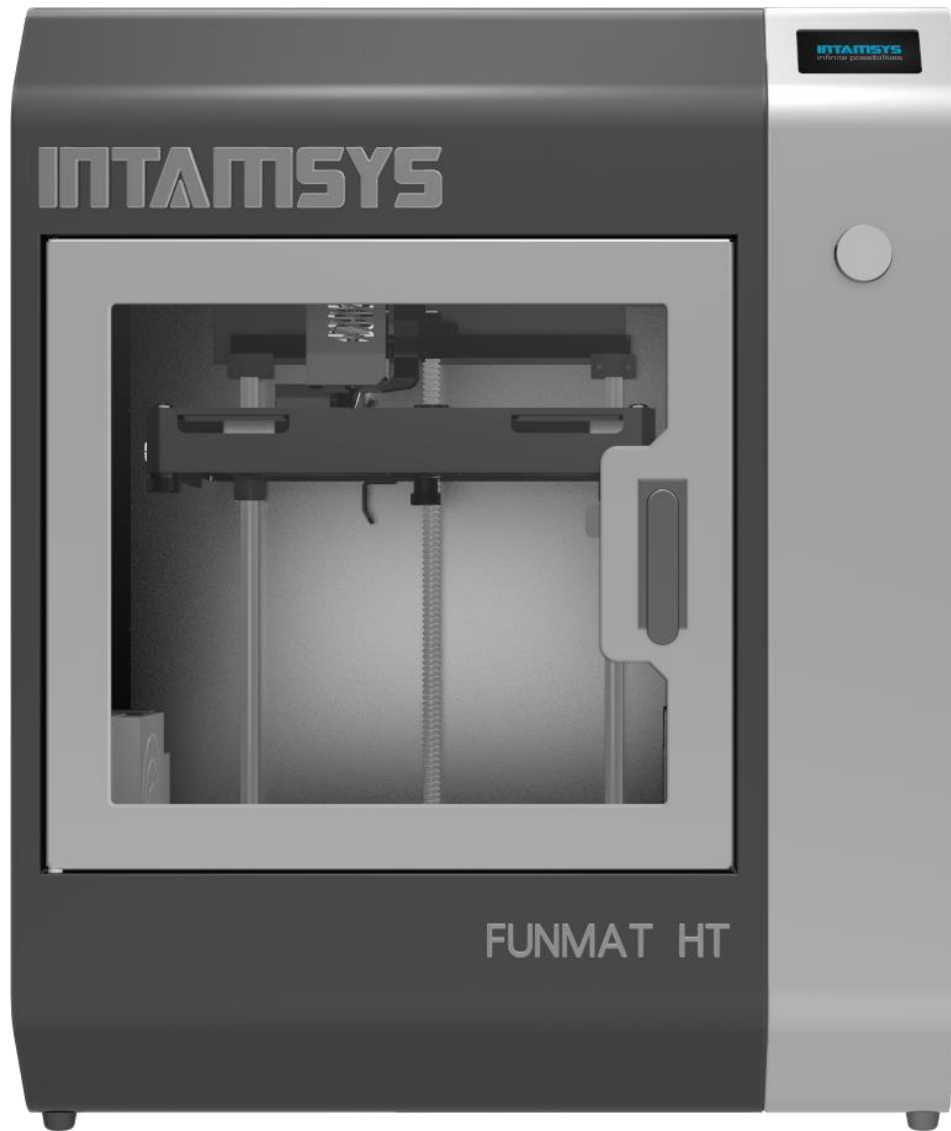

FUNMAT HT 3D PRINTER

User Manual



High Performance Functional Materials 3D Printer

Disclaimer

Please read and understand the contents of this user manual carefully. Failure to read the manual may result in lead to personal injury, inferior results, or damage to the machine. Always ensure that anyone who uses the 3D Printer knows and understands the contents of this manual to make the most out of the 3D Printer.

The conditions or methods under which the machine is assembled, handled, stored, used, or disposed of are beyond our control and may be beyond our knowledge. For this and other reasons, we do not assume responsibility and expressly disclaim liability for any loss, injuries, damages, or expenses arising out of or in any way related to the assembly, handling, storage, use, or disposal of this product.

The information in this document was obtained from sources that we believe to be reliable. However, the information is provided without any warranty, express or implied, regarding its correctness.

Intend Use

INTAMSYS 3D Printers are designed and built for fused deposition modeling of various functional plastics such as PEEK, PEI, ABS, PC, NYLON or TPU within a commercial/business environment. The mixture of precision and speed makes INTAMSYS 3D Printers the perfect machines for concept models, functional prototypes, and the production of small batches. Although we achieved a very high standard reproduction of 3D models with the usage of Intamsuite, the user remains responsible to qualify and validate the application of the printed object for its intended use. INTAMSYS 3D Printers are open platform machines, meaning you can use any third party filaments, but to get the best results we recommend you use INTAMSYS certified filaments, as they are customized for made for INTAMSYS 3D Printers.

CONTENTS

01	SAFETY AND COMPLIANCE	4
	Safety	5
	Hazards	6
02	INTRODUCTION	7
	About Intamsys	8
	Contact Details	8
	Printer Overview	9
	Printer Specifications	11
03	GETTING STARTED	12
	Accessories Checklist	13
	Unpacking The Printer	14
	Setting Up The Printer	17
04	LCD DISPLAY OVERVIEW	20
05	REGULAR OPERATION	24
	Change Material	39
	Other Functions	43
	Change Nozzle Set	47
	Change Nozzle Only	50
	Remove Print & Clean Supports	52
06	MAINTENANCE	53
	Updating Firmware	54
	Cleaning the Glass Plate	55
	Cleaning Feeder	57
	Cleaning Nozzle	58
	Lubricate Axis	59
	Lubricate Guide Pin	59
	Filament Care	60
07	TROUBLESHOOTING	61
08	SOFTWARE OVERVIEW	68
09	GLOSSARY	76



SAFETY AND COMPLIANCE

It is very important to work safely with your FUNMAT HT 3D Printer. This chapter contains details about safety and hazards. Please read all information carefully to prevent accidents and injuries.

SAFETY

Safety

Movement Safety

The machine is very heavy, so when unpacking the machine or moving the machine from one location to another, always use another person's assistance. Additionally, keep the machine on a flat ground with enough space on all sides to operate the machine without any difficulty.

Electrical Safety

The power supply meets all CE regulations and is protected against short-circuits, overloading, over voltage, and overheating. Make sure you only use the power supply cable you received from INTAMSYS.

Mechanical Safety

The machine has many moving parts, but the stepper motors do not have enough power to cause serious injuries. Still, we advise you to only reach into the machine when it is turned off.









High Temperature Safety

FUNMAT HT comes with an all-metal nozzle, high-temperature build plate, and heated chamber. When printing functional materials with a chamber temperature of up to 90°C, the heat transmits to the outer frame, so we advise you not to touch the machine during the printing process. The nozzle can reach temperatures of up to 450°C, and the heat bed can reach temperatures of up to 160°C during the printing process. Thus, we strongly advise you not to touch the nozzle & heat bed when the printer is working. Additionally, let the printer cool down before opening the front door or the top door of the machine.

Hazards



Safety alert symbols precede each safety message in this manual. These symbols indicate potential safety hazards that could harm you or others or cause damage to the product or property.

-  **Warning:** Do not leave the machine unattended during operation.
-  **Warning:** Always power off the printer before doing any maintenance.
-  **Warning:** Do not touch the nozzle or the heat bed when the printer is in operation.
-  **Warning:** After the print is done, using gloves to take out the objects.
-  **Warning:** The machine includes moving parts that can cause injury. Never reach inside the machine while it is in operation.
-  **Warning:** There is a risk of electrical shock, do not touch any electrical parts when power on.
-  **Caution:** In case of emergency, disconnect the machine from the wall socket.
-  **Caution:** The machine melts plastic during printing, and thus emits plastic odors. Make sure to set up the machine in a well-ventilated area.

Please visit our website www.intamsys.com to learn more about support.



INTRODUCTION

INTAMSYS is an industrial 3D Printer manufacturer renowned for its “world’s most affordable PEEK 3D Printer” , FUNMAT HT. It has offices in Shanghai, Dongguan, and Nanjing, with resellers present across the world.

ABOUT INTAMSYS

About Intamsys

INTAMSYS (Abbreviation of **INT**elligent **A**dditive **M**anufacturing **SYS**tems) is an industrial-grade 3D printers' manufacturer specialized in high performance engineering thermoplastics 3D printing. The company was founded by a team of engineers with in-depth experience and know-how in engineering high-precision industrial machinery and equipment.

The company's state-of-the-art FUNMAT 3D Printers are designed for high performance functional materials 3D printing at affordable prices. FUNMAT is the abbreviation of functional materials. INTAMSYS is committed to the highest manufacturing design and quality standards where all INTAMSYS 3D printers have received FCC and CE certifications. Today, INTAMSYS is trusted globally by customers from aerospace, medical, automotive and research institutions, etc.

Please visit www.intamsys.com for more information.

Contact Details

There are multiple ways to reach out to INTAMSYS as we have a strong online presence.

E-mail: Send an e-mail to info@intamsys.com or support@intamsys.com, and we will respond within 24 hours Phone: +86-21-5846 5932

Facebook: <http://www.facebook.com/intamsys>

Website: <https://www.intamsys.com>

Skype: intamsys

Twitter: https://twitter.com/intamsys_3d

Linked In: <https://www.linkedin.com/organization/16240248/>

PRINTER OVERVIEW

Printer Overview

- 01. Display Screen
- 02. Push/Rotate Button
- 03. SD Card Slot
- 04. Filament Box
- 05. Front Door Lock



Figure 2.1

- 06. Power Switch
- 07. Power Socket
- 08. USB Socket

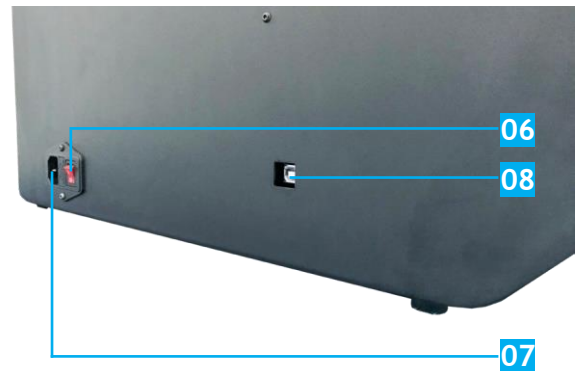

Figure 2.2

PRINTER OVERVIEW

- 09. Cooling Fan
- 10. Nozzle
- 11. Auto-Level Sensor

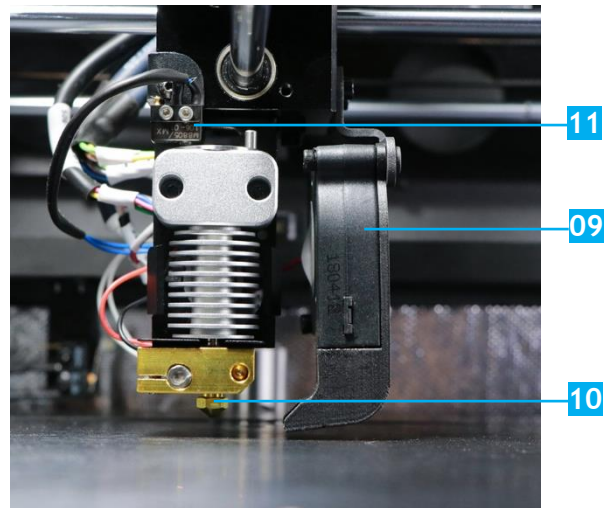

Figure 2.3

- 12. Filament Tube
- 13. Push Button--Control The Drive Gear

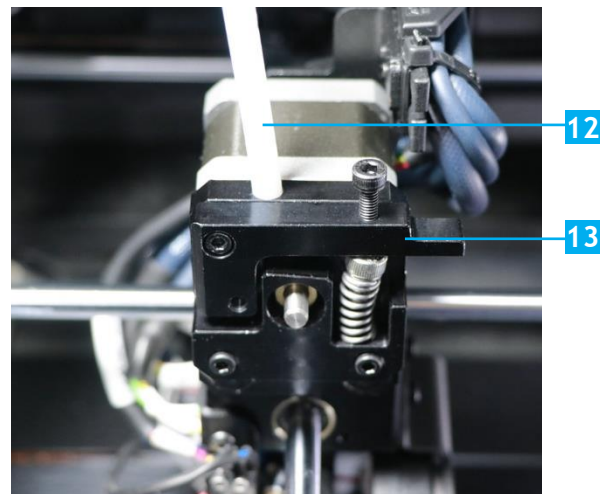

Figure 2.4

- 14. Heating Bed (Under the Glass)
- 15. Glass Plate
- 16. Glass Holder

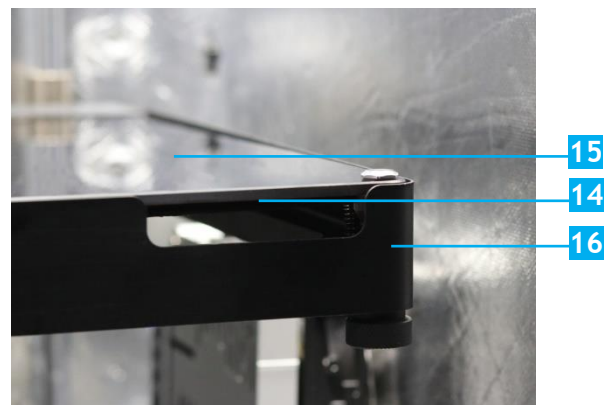

Figure 2.5

PRINTER SPECIFICATIONS

Printer Specifications

PRODUCTS	FUNMAT HT
Printing Technology	FFF
Extruder	Single
Extruder Diameter	Swappable 0.25, 0.4, 0.6 and 0.8mm nozzle, default 0.4mm
Layer Resolution	0.05-0.4mm
Position Accuracy	XY:0.025mm, Z:0.0025mm
Print Speed	30-200mm/s
Filament Diameter	1.75mm
Build Platform	PI + Glass Ceramics
Supported Filament	PEEK, PEKK, PEI, PPSU, ABS, PC, Nylon, Carbon Fiber-Filled, PETG, PVA, PLA, TPU, HIPS, Woodfill, Metalfill, etc.
Language	Chinese & English
User Interface Features	Full-color Touch Screen
Connectivity	SD card, USB
Camera	Yes
Power Failure Recovery	Yes
Filament Absent Warning	Yes
Build Plate Leveling	Auto Leveling, Manual Leveling
Build Volume	10.3"*10.3"*10.3"(260*260*260mm)
Dimensions	530*490*645mm
Weight	46kg
Heated-Plate Temperature(MAX)	160°C/320°F
Extruder Temperature(MAX)	450°C/842°F
Heated Chamber(MAX)	90°C/194°F
Software	INTAM-Suite(our free 3D printing slicing software); Compatible Software: Simplify3D & Cura
Input Supported File Type	.Stl, .Obj, .Obj, .X3D
Output Supported File Type	Gcode
Operating Environment	Temperature: 15°C To 32°C (59°F To 89.6°F) Humidity: 30% To 70%
Storage Environment	Temperature: 0°C To 54°C (32°F To 129.2°F) Humidity: 10% To 85%
Material Storage Environment	Temperature: 13°C to 24°C (55.4°F To 75.2°F) Humidity: 20% To 50%
Voltage Input	100~120VAC (110V Version only, refer to the nameplate) 200~240VAC (220V Version only, refer to the nameplate) 47~63Hz
Power	1200W

03

GETTING STARTED

In this chapter you will find information on accessories, components of 3D Printers, and setting up your machine.

ACCESSORIES CHECKLIST

Accessories Checklist

The accessories tray includes everything you need to use your FUNMAT HT 3D Printer. Below is the list of accessories included with the machine.

Power Cord	SD Card & Electronic Files	Card Reader
USB Cable	Cutting Pliers	Tweezers
Removal Tool	Glass Plate	Glass Plate Assembly
Nozzle Set	Filament	Allen Key
Socket Wrench	Spanners	Leveling Card
Oven Gloves	Feed Gear	Nozzles
Driving Motor	PEEK Tube	Zip Ties
Quick Start Guide	Camera Guide	

UNPACKING THE PRINTER

Unpacking The Printer

Put the printer on flat ground before you unpack it.

Step 1: Open the box.



Figure 3.1

Step 2: Remove the accessories tray and take the machine out of the box.



Figure 3.2



Figure 3.3

UNPACKING THE PRINTER

Step 3: Gently place the printer on a flat, solid, and sturdy platform. Connect the power cable and power on your printer.



Figure 3.4

Step 4: Lower down the build plate by clicking “Settings” → “Other Settings” → “Buildplate to the bottom”. Open the front door and carefully remove the styrofoam fixer above the build plate, then power off the printer.



Figure 3.5

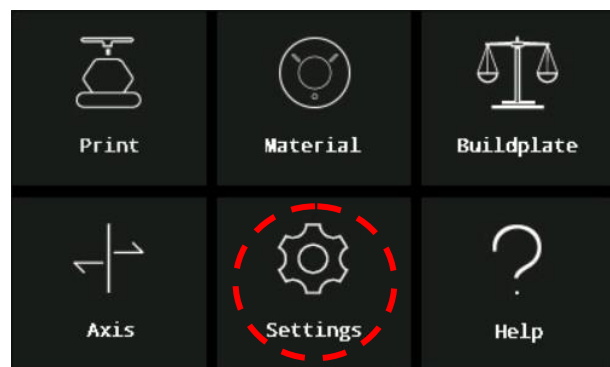

Figure 3.6

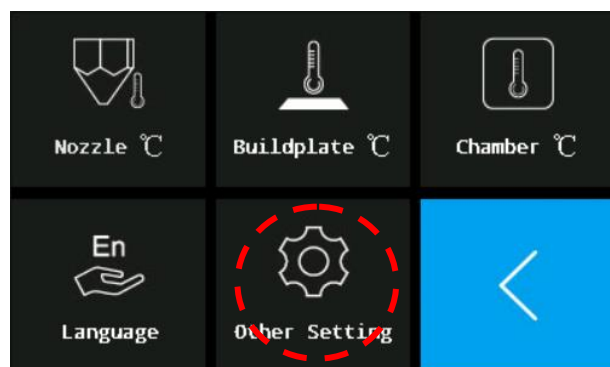

Figure 3.7

UNPACKING THE PRINTER

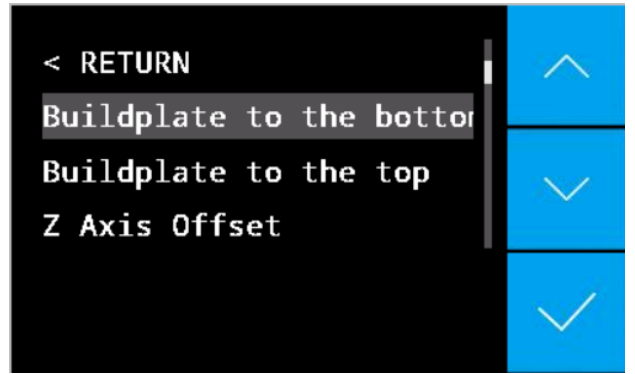

Figure 3.8

Please keep all packaging materials for warranty purpose.

SETTING UP THE PRINTER

Setting Up The Printer

Release the Printing Head

When you open the top door, you will find that the printing head is locked in position by four screws. Release the X & Y axes before you use the printer.

To do so:

Step 1: Power off the printer. Use the Allen key and socket wrench to remove the four screws and free the X & Y axes.

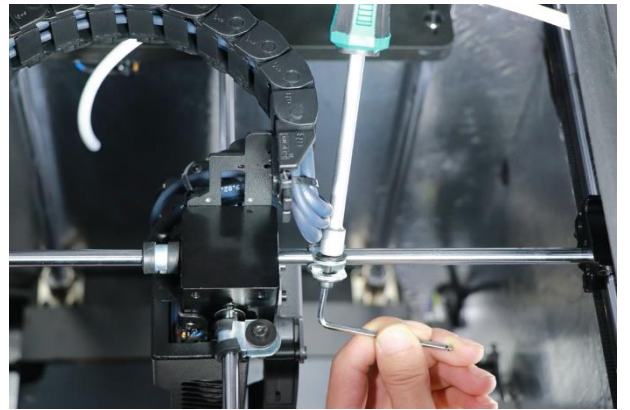

Figure 3.9

Step 2: Install the motor on top of the extruder and ensure the PEEK tube is securely inserted into its position. Connect the motor connector to P7 on the pin board, secure the cables with a zip tie.

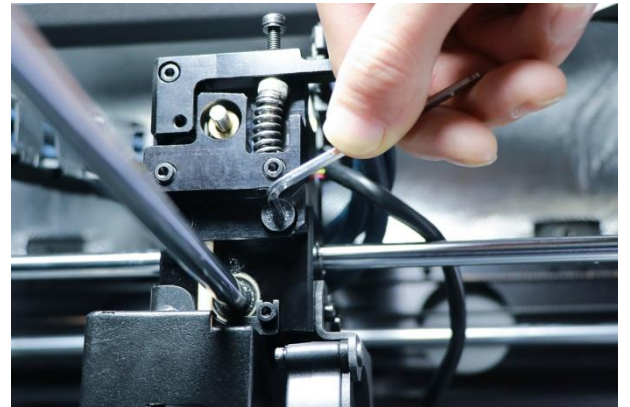

Figure 3.10

SETTING UP THE PRINTER

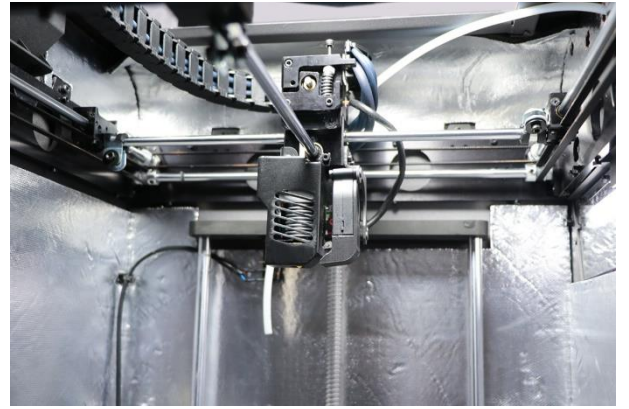

Figure 3.11

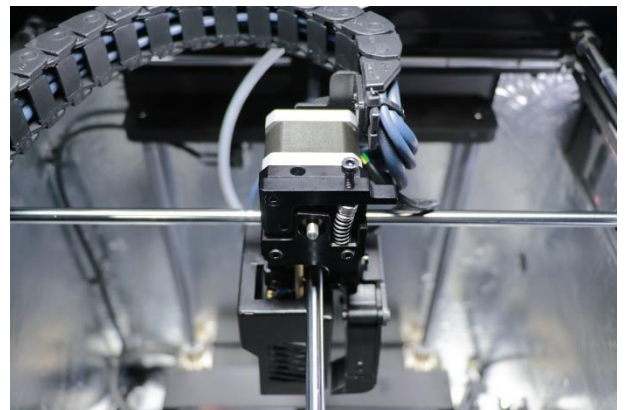

Figure 3.12

SETTING UP THE PRINTER

Set Up the Build Plate

Locate the glass plate assembly in the accessories tray. Take the glass plate assembly out and put it onto the platform as shown in the picture. Align the three magnets of the glass plate to the glass holders on the platform.

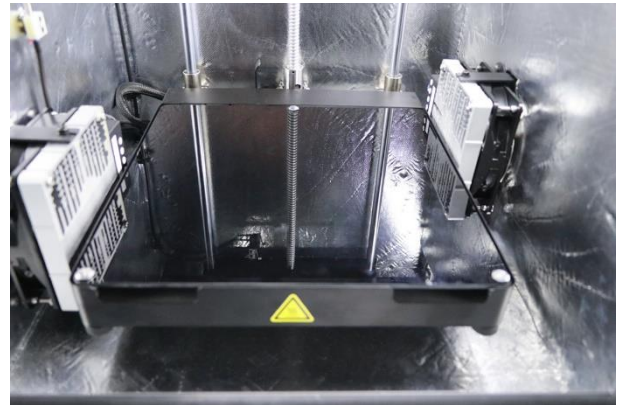

Figure 3.13

Powering On the Printer

Step 1: Connect the power cable.



Figure 3.14

Step 2: Flip the power switch to the ON (I) position.

The printer will begin to boot. The touch-screen will turn on and the INTAMSYS logo followed by start-up code will be displayed for a brief period.



Figure 3.15

04

LCD DISPLAY OVERVIEW

The LCD Display can be broadly divided into seven sections. In this chapter, you will find a brief overview of the LCD Display.

LCD DISPLAY OVERVIEW

The menu tree is shown as figure 4.1.

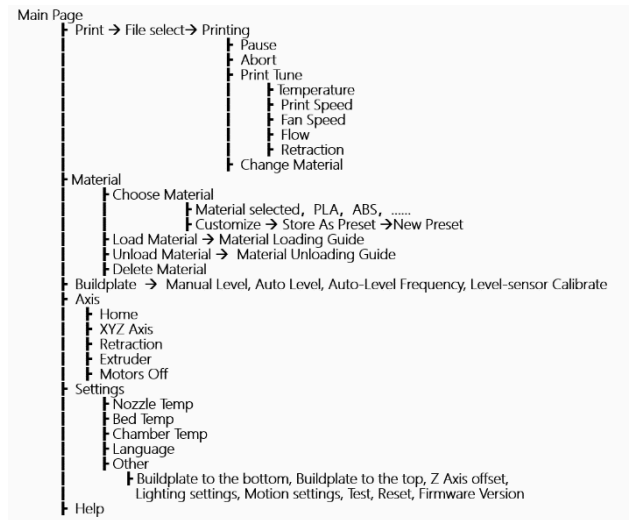

Figure 4.1

Introduction

This is the screen that gets displayed when you switch on the machine. The Startup screen includes:

- a) Intamsys Logo;
- b) Screen Firmware Version, e.g. “LCD3P2 V2.0”;
- c) Machine Firmware Version “HT1.5_190313”



Figure 4.2

Main Screen

The welcome screen is immediately followed by the main screen as shown on the right. On the main screen, there are six sections – (a) Print (b) Material (c) Buildplate (d) Axis (e) Settings (f) Help.

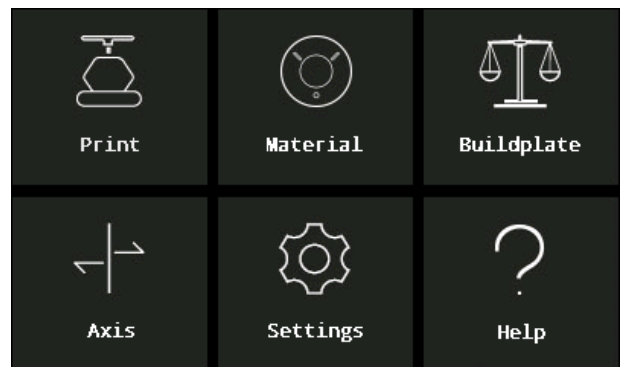

Figure 4.3

LCDDISPLAYOVERVIEW

Print Screen

When you select the "Print" option, it will ask you to choose the file you wish to print. Once you choose your file, the screen on the right appears. On this screen, you can find the temperature of the nozzle, the build plate, and the chamber, as well as the material type being used, the total print time, and the print progress.



Figure 4.4

Material Screen

On this screen, you can select the material you wish to print from a pre-determined list of filaments. If you have a filament that is not present on the list, you can also add a new kind of filament and customize its settings by selecting "Customize." You can also load and unload a filament on the "Material" screen.

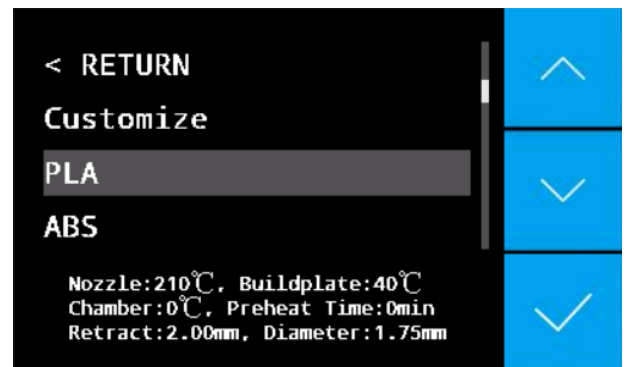

Figure 4.5

Buildplate

There are three sub-menus. A)Manual Level, B)Auto Level, C)Auto-level Frequency, D)Level-Sensor Calibrate. Customer can manually level the build plate by selecting Manual Level and follow the instructions on the LCD screen. The Auto Level is easier to use, the printer will automatically detect the buildplate plane position by click this menu. The Level-Sensor Calibrate function helps to calibrate the distance between nozzle and level sensor.

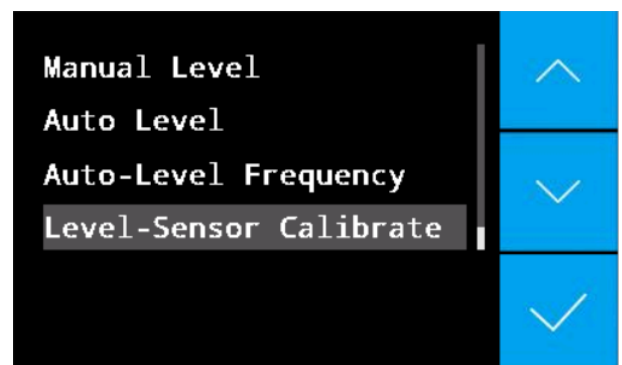

Figure 4.6

LCD DISPLAY OVERVIEW

Axis

In this screen, you can perform axis movement tasks such as homing the axis, moving the nozzle mechanism in the X, Y direction, and modifying retraction settings.

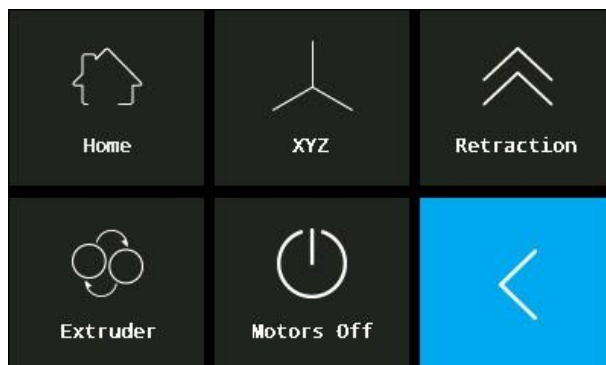

Figure 4.7

Settings

On this screen, you can modify nozzle temperature, build plate temperature, and chamber temperature. You can also change the language and modify some other parameters.

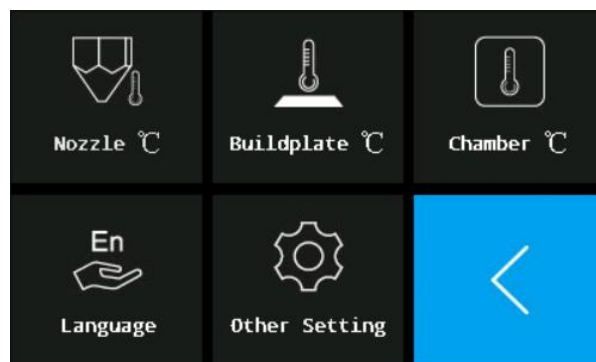

Figure 4.8

Help

On this screen, you can find brief reading material on the various icons on the LCD screen and their functionality.

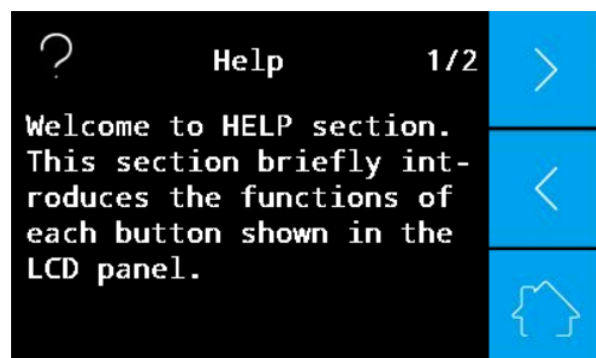

Figure 4.9



REGULAR OPERATION

This chapter provides information about regular day-to-day usage of the printer.

LEVELING THE BUILD PLATE

Leveling The Build Plate

Build plate leveling is a prerequisite for successful printing of models. The objective of this exercise is to make sure the build plate is flat and at an exact distance from the nozzle. In order to adjust the gap between the nozzle and the print platform glass to about 0.2mm (about the thickness of a standard leveling card), you only need to use a leveling card or leveling device for a simple manual adjustment.

This printer also provides auto leveling function, it detects three points' position, then the algorithm will automatically adjust the gap between the nozzle and the platform during printing.



Figure 5.1

Note: Before leveling, please confirm that all parts of the machine have been installed correctly, (no loose parts, etc.) and there is no foreign body above or below the printing platform.

LEVELING THE BUILD PLATE

Manual Leveling

Step 1: Take out the leveling card from the accessories tray. If you lose the card, you can also use two standard sheets of A4 paper (~0.2mm). Enter the main interface of the machine and click "Buildplate." → "Manual Level", follow the screen prompts for the leveling operation.

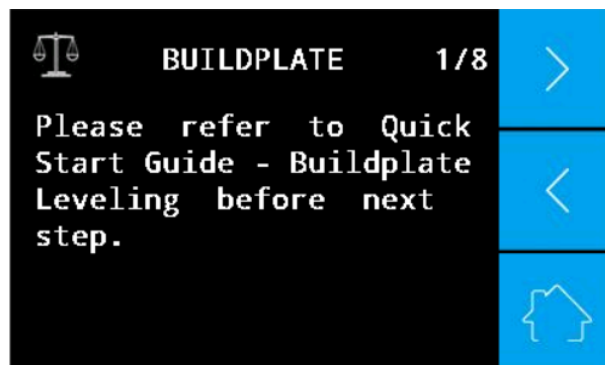

Figure 5.2

Step 2: The build plate has rotating screws underneath it. One is in the center at the back, one in the front left and the other in the front right. When you start leveling the bed, the machine will automatically move the nozzle above the screw you should adjust. Starting with the center screw, turn clockwise to decrease the distance and turn counter-clockwise to increase the distance between the nozzle and the build plate. The gap between the nozzle and the build plate should be such that when you slide the leveling card (shipped along with the machine) between the two you can feel a little bit of friction on the card.

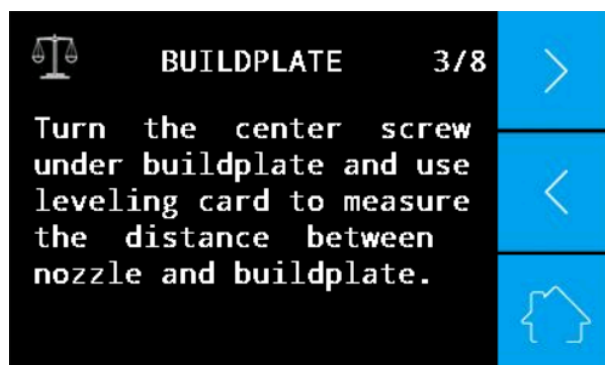

Figure 5.3



Figure 5.4

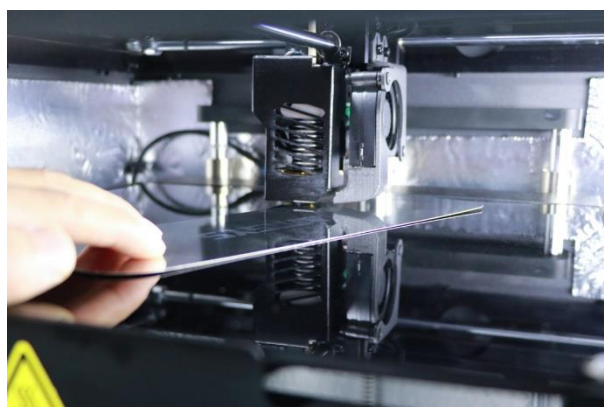

Figure 5.5

LEVELING THE BUILD PLATE

Step 3: Now repeat the same procedure for the left and right screws underneath the build plate.

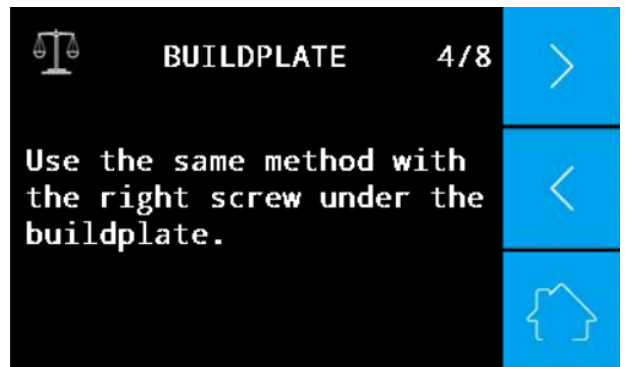

Figure 5.6

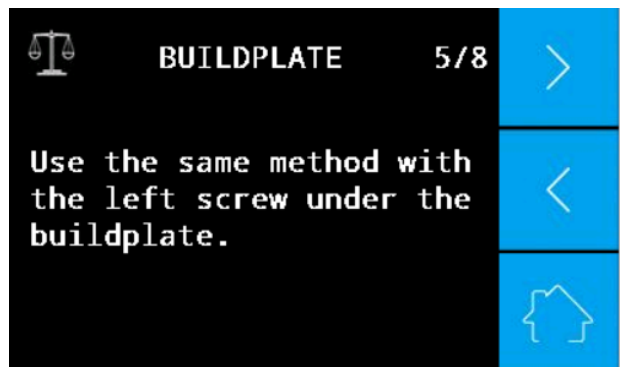

Figure 5.7

Step 4: For more accuracy, you need to repeat the manual level again, then complete leveling, you are ready to load the filament into the nozzle.

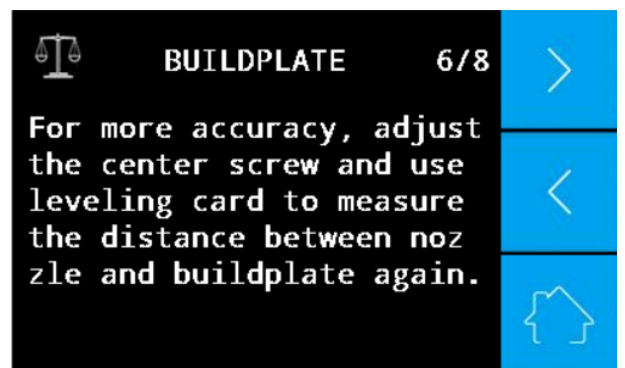

Figure 5.8

Note:

- 1) If you choose the Manual Leveling option. Before printing materials for which a heated chamber is needed (like PC, ABS, etc), please firstly set the chamber temperature to the desired printing temperature and maintain it for at least 30min before leveling. It is important to heat the chamber before leveling the build plate, as the build plate may rise when chamber is heating.
- 2) When printing, in the event that the filament does not extrude or the extrudate does not adhere to the glass plate, you can adjust the three screws under the build plate until the filament extrusion is smooth and achieves good adhesion to the glass plate.

LEVELING BUILD PLATE

Auto Leveling

Step 1: Verify the auto leveling sensor is healthy.

Go to the main menu, click “Settings” → “Other Settings” → “Test” → “Leveling sensor”. The nozzle will be heated up. Wait for approx. 2 minutes, follow the instruction on the screen, use a removal tool to touch the nozzle, and then lift the nozzle approx. 1mm up. It will show the following message “The leveling sensor is triggered”.

Note: *IF the leveling sensor doesn't work, do not perform the auto leveling function, the nozzle may break the glassplate!*

Note: *This step is not required every time, if you change the nozzle set or leveling sensor or change the change cables in pin board this step is necessary. We also suggest you to do this test every one month.*

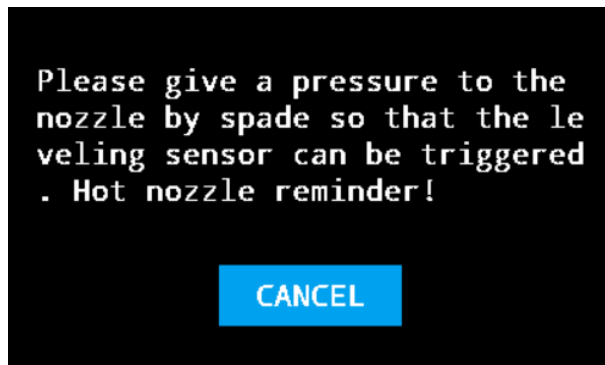

Figure 5.9

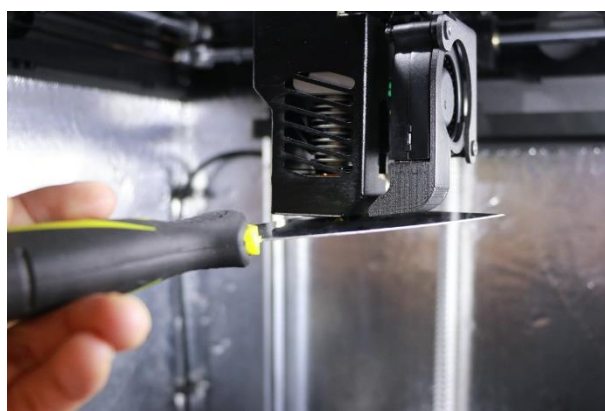

Figure 5.10

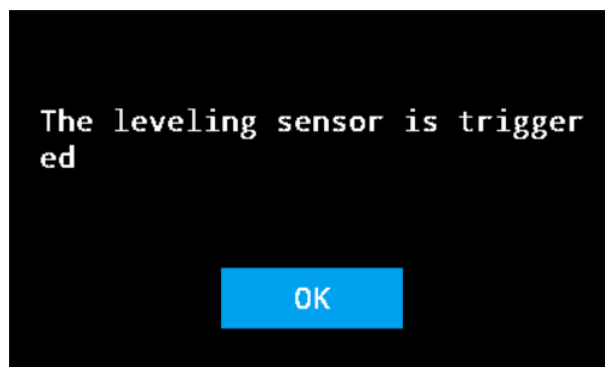

Figure 5.11

LEVELING THE BUILD PLATE

Step 2: Go back to the main menu, and click “Buildplate” → “Level-Sensor Calibrate”. Follow the instruction to complete the calibration. The nozzle heating temperature depends on the selected material.



Figure 5.12

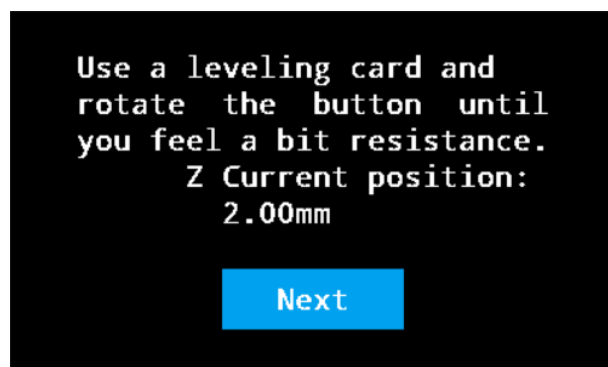

Figure 5.13

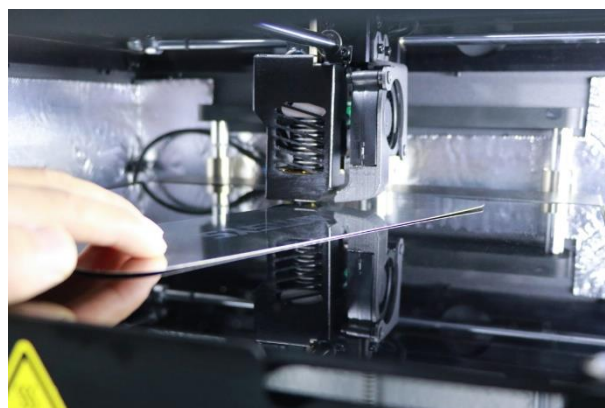

Figure 5.14

Note: This step is not required every time, if you change the nozzle set or leveling sensor, this step is necessary. If the printed 3D model can't adhere to the glass plate, re-do this step before auto-leveling.

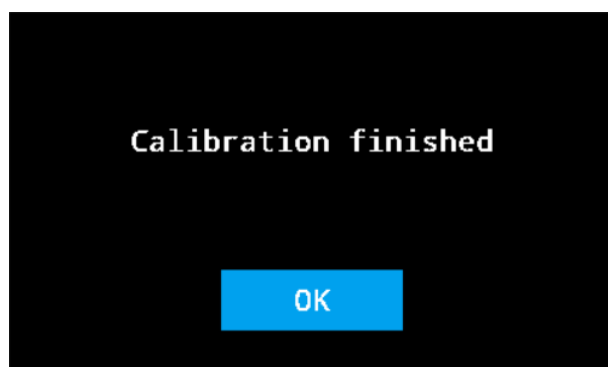

Figure 5.15

LEVELING THE BUILD PLATE

Step 3: Click “Auto Level”, printer will automatically finish the auto leveling process without any human interference. Firstly, the machine will preheat the buildplate and chamber for a specific time, then preheat the nozzle. The preheating temperature and time follow the material selected. Once reached the set temperatures and time, the printer will start auto leveling. The printer shows “Auto level successfully” once auto leveling is done. The printer is ready to print now.

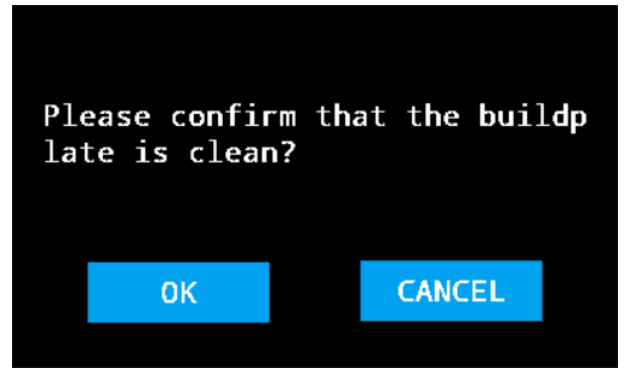

Figure 5.16

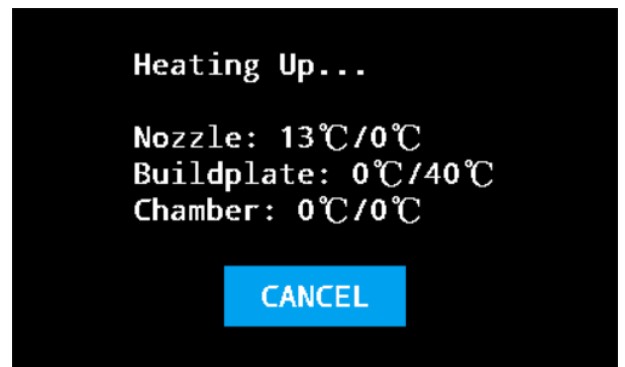

Figure 5.17



Figure 5.18

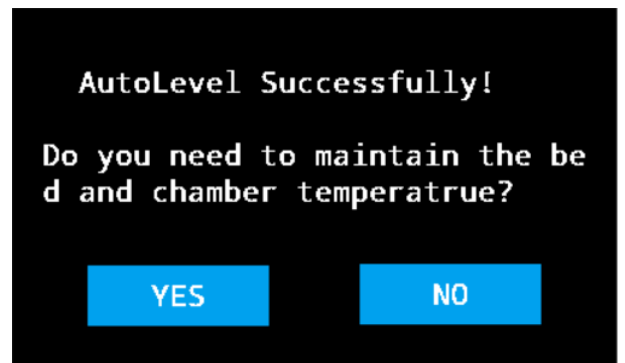

Figure 5.19

Note: When printing, in the event that the filament does not extrude or the extrudate does not adhere to the glass plate, re-do the step 2 & step 3.

CHOOSE MATERIAL

Choose Material

There are two ways to choose the material you want to print.

- 1) Choose material directly in the default material list, like PLA, ABS, PC,.... And settings are shown in the screen bottom.
- 2) Update material settings or name a new material.

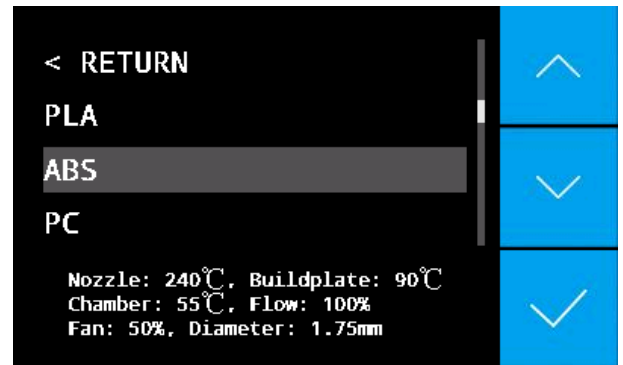

Figure 5.20

Step 1: Click “Customize” at the begin of the material list, then you can modify settings like Nozzle Temp, Buildplate Temp, Chamber Temp, Preheat time, Diameter, Flow%, Retract Length, Retract Speed, Maitain Buildplate Temp, Maitain Chamber Temp, Maitaining Time, etc.

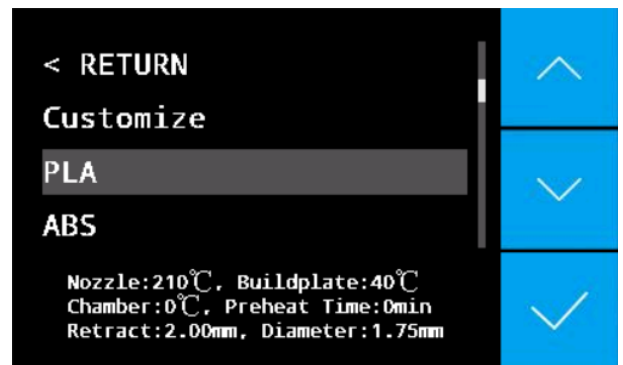

Figure 5.21

Step 2: Click “Store as Preset”, you can override the material settings by clicking each material in the list, OR you can edit a new material by clicking “New Preset” and you can also name it and then store it.

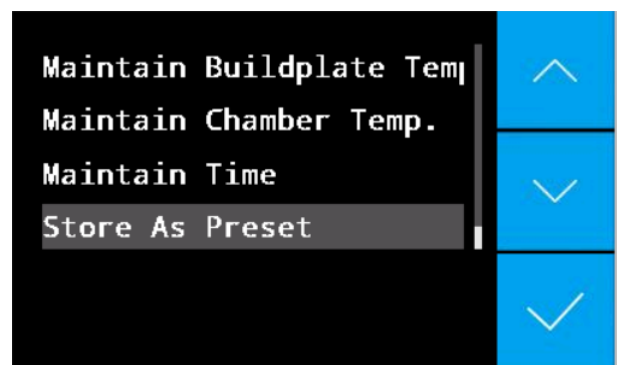

Figure 5.22

CHOOSE MATERIAL



Figure 5.23



Figure 5.24

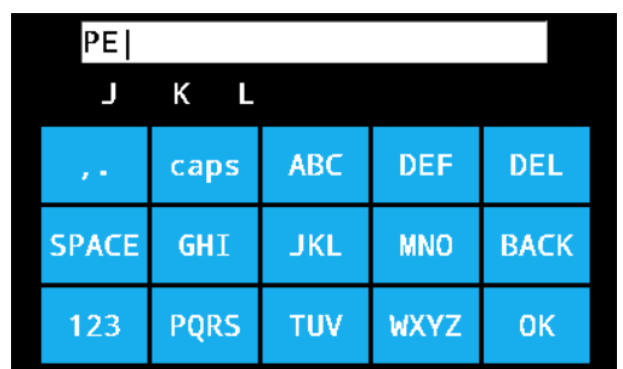

Figure 5.25

LOADING FILAMENT

Loading Filament

Step 1: Open the door on the right side of the machine and place the filament spool on the bracket.



Figure 5.26

Step 2: Take the end of the filament from the spool holder and pass it through the limit switch into the guide tube to reach the extruder.



Figure 5.27

Step 3: Select "Material" and choose the material you wish to load. Then select "Load Material."

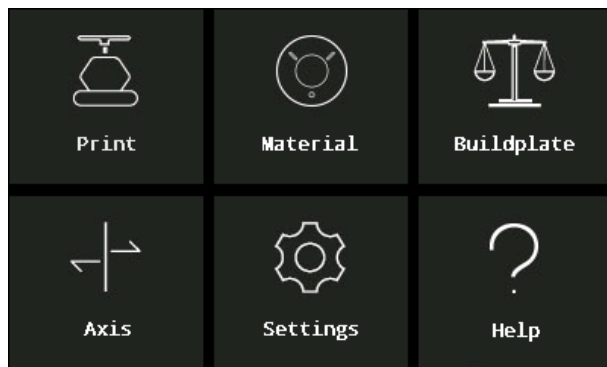

Figure 5.28

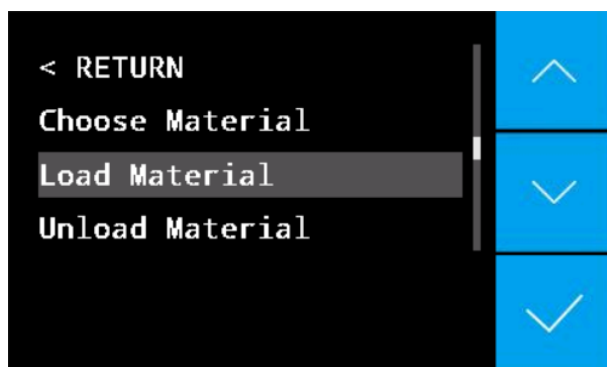

Figure 5.29

LOADING FILAMENT

Step 4: Refer to the guide on the screen and wait for the nozzle temperature to rise to the required temperature.

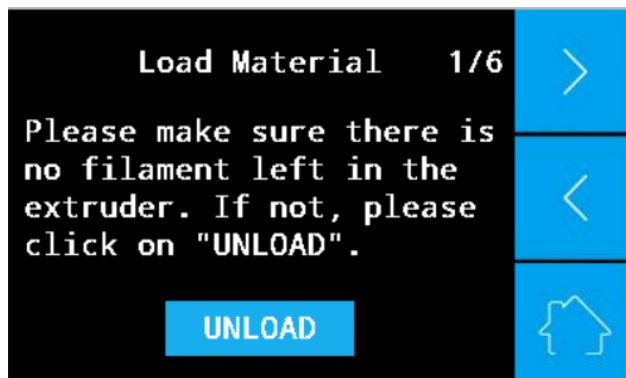

Figure 5.30

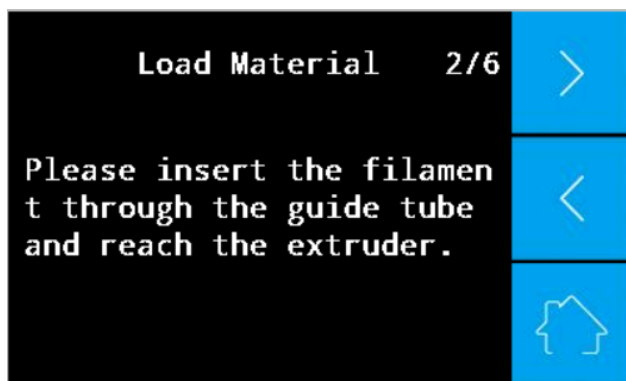

Figure 5.31

Step 5: Select "Material" and choose the material you wish to load. Then select "Load Material."

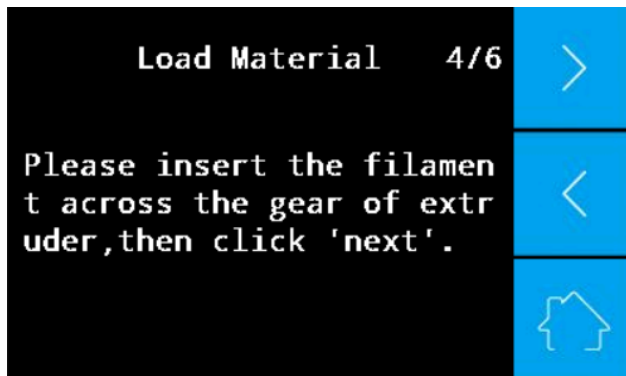

Figure 5.32

Step 6: Pull out the guide tube from the extruder and insert the filament into the feed gear. When the filament goes into the feed gear, place the guide tube back into position and proceed to the next step on the display.



Figure 5.33

LOADING FILAMENT

Step 7: According to the timer on the screen, wait until the filament extrudes smoothly from the nozzle. The filament is now loaded.

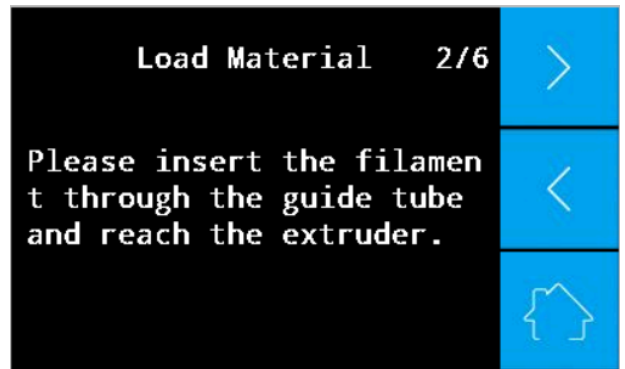

Figure 5.34

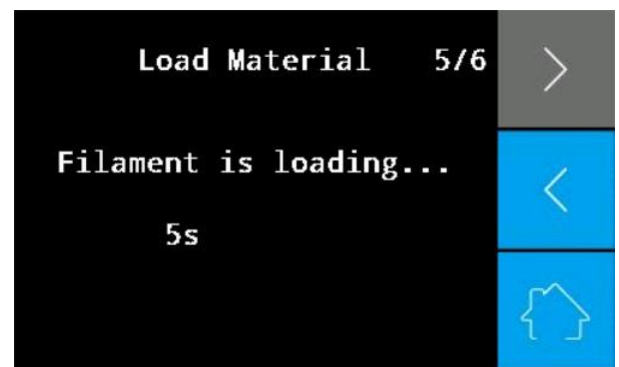

Figure 5.35

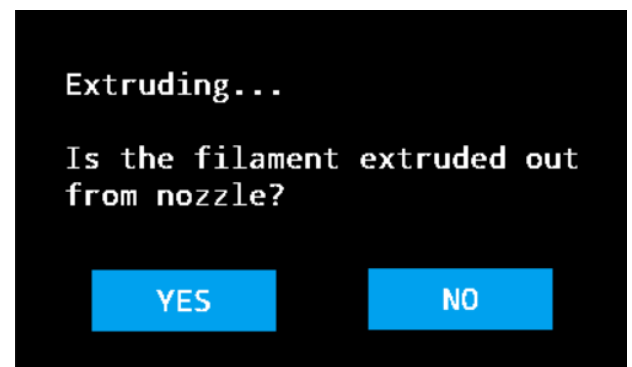

Figure 5.36

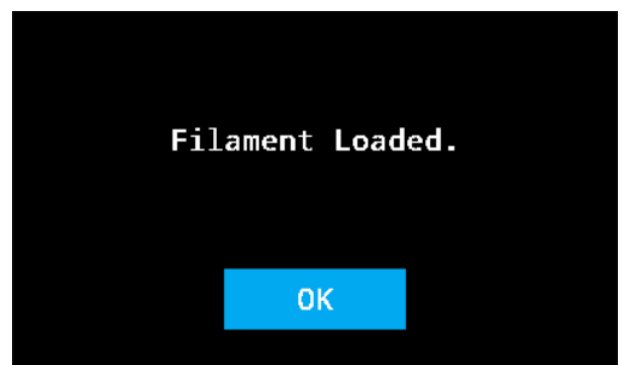

Figure 5.37

LOADING FILAMENT



Figure 5.38

-  **Caution:**
- The nozzle is very hot when the material is being extruded. Be careful not to touch the nozzle during the loading process.

PRINT FILE

Print File

Step 1: Prepare the build plate for printing with



Figure 5.39

Step 2: Insert your SD card with the file you wish to print. Select the “Print” button and select the file you wish to print. Wait for the machine to heat up to the required temperature. The screen will be as shown during the printing process. The time it takes to print the file, the material being used, the nozzle temperature, the build plate temperature, and the chamber temperature are all displayed on the screen. You can abort the print, pause the print, and modify the settings using the settings icon.

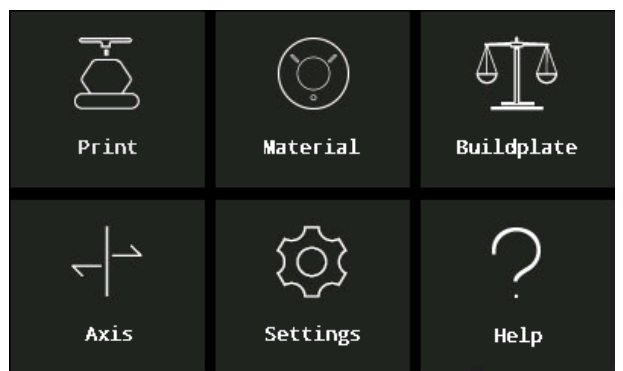

Figure 5.40



Figure 5.41

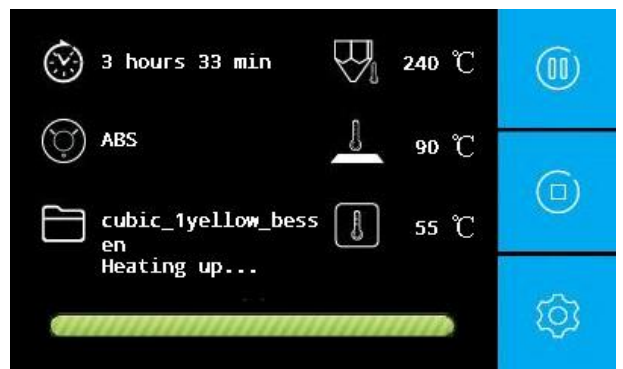

Figure 5.42

PRINT FILE

Step 3: When you select the settings icon during the printing process, the following screen will be displayed. Here you can change temperature, print speed, fan speed, material flow, and retraction settings.

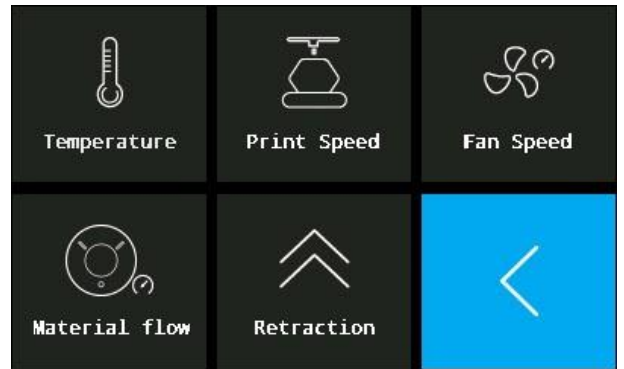

Figure 5.43

CHANGE MATERIAL

Change Material

Change Material During Printing

Step 1: Select the pause icon from the display.

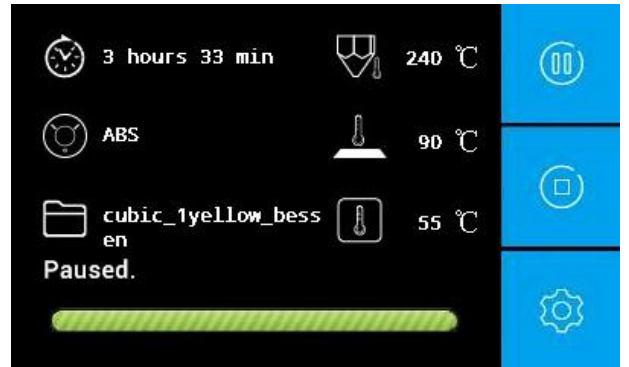

Figure 5.44

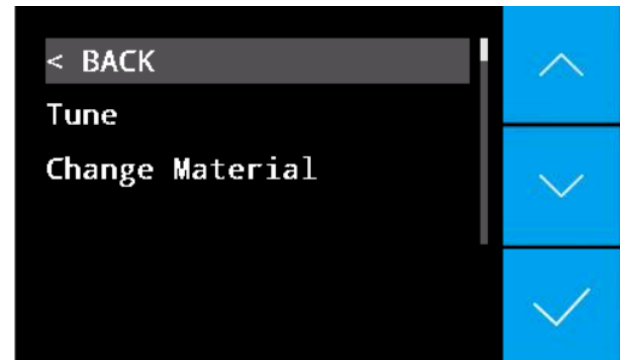

Figure 5.45

Step 2: When the nozzle stops, click settings and Select “Change Material”, then follow the instruction to pull out the guide tube and filament.

CHANGE MATERIAL

Step 3: When loading the new material, insert the material directly between the feed gear and groove and push a small amount of material through the nozzle by hand. Be sure to change the temperature settings to those required for your new material.

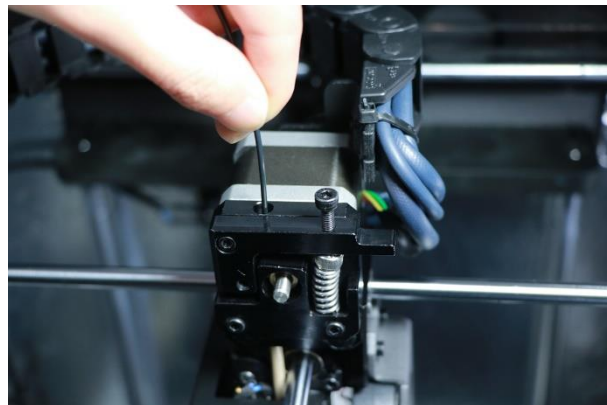

Figure 5.46



Figure 5.47

Step 4: Resume printing by pressing the resume icon.

Note: To avoid plugging the nozzle, do not change out a material for one with a lower melting temperature.

CHANGE MATERIAL

Change Material When Filament Is Absent

This printer has a function of Filament Absence Warning, that means the printer will pause and give the warning when filament is used up. After loading the new replaced filament, the printer will continue the printing.

Step 1: When the filament is absent, the screen shows as the right figure. Select the “Change Material” icon, and then follow the instruction to unload the old filament and take out the old filament spool from the filament chamber. Next install a new spool of filament and load the new filament.

Step 2: Resume printing by pressing the resume icon after new filament is well loaded.

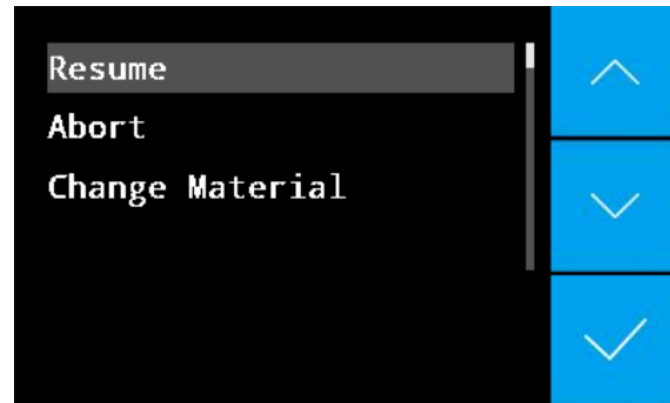

Figure 5.48

i



Figure 5.49

CHANGE MATERIAL

Change Material After Printing

Step 1: If you want to change to a new material, go to "Material " then "Unload Material."

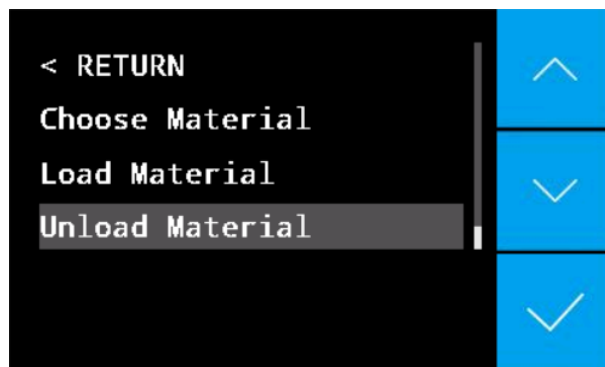

Figure 5.50

Step 2: Refer to the guide on the screen and wait for the nozzle temperature to rise to the required temperature. Wait until the old filament reverses from the filament tube.

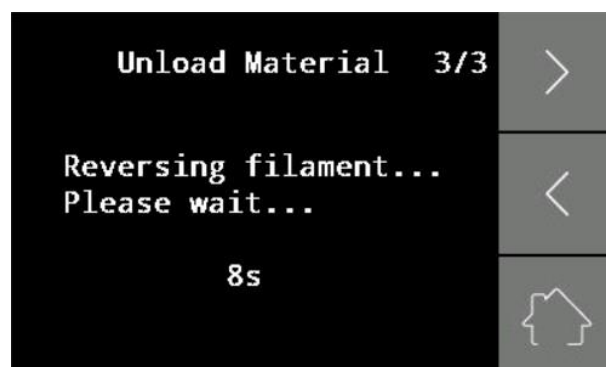

Figure 5.51

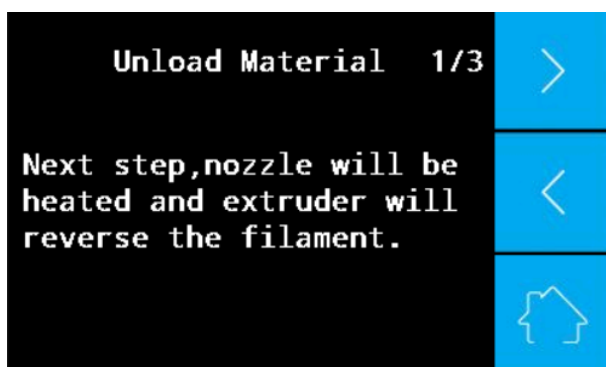

Figure 5.52

Step 3: Load the new material. Select "Material " then "Load Material." If you wish to change the material, firstly select "Choose Material" and then load the filament. Please check the Loading Filament section of this manual to learn more about how to load the filament.

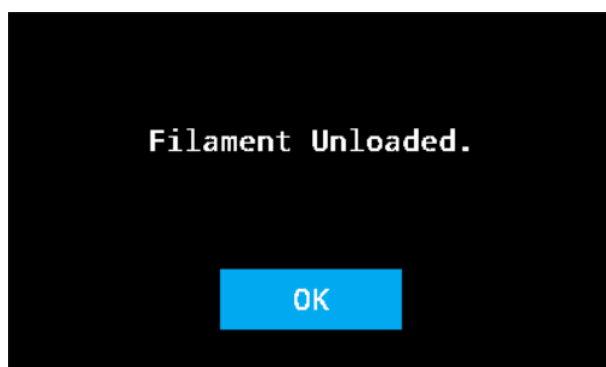

Figure 5.53

Note: To avoid plugging the nozzle, do not change out a material for one with a lower melting temperature.

OTHER FUNCTIONS

Other Functions

Axis Movement

The Axis section is for manually using the motors to adjust the X, Y, & Z coordinates.

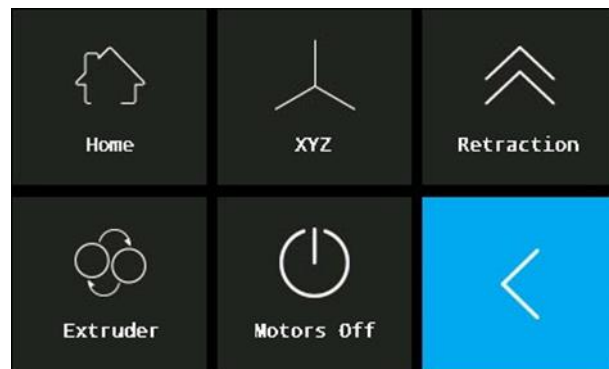

Figure 5.54

Home

Select this function to return to the home X, Y, & Z positions.

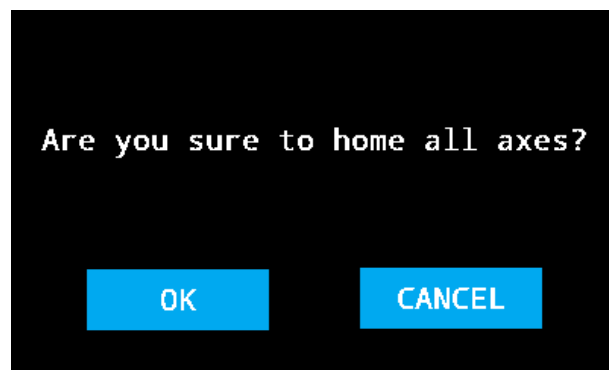

Figure 5.55

XYZ

This function changes the X, Y, & Z coordinates manually. You can press the buttons or use the dial to move the nozzle and build plate to the desired locations.

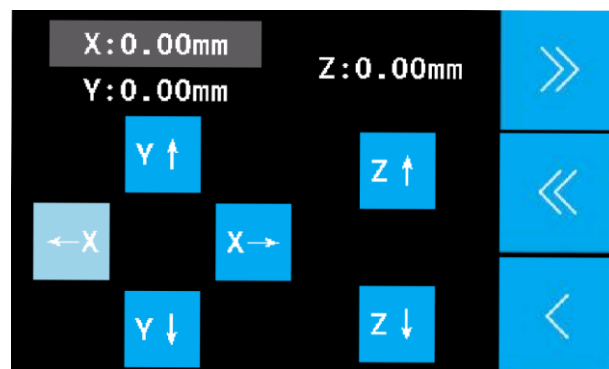

Figure 5.56

OTHER FUNCTIONS

Retraction

This option is used to set the max retraction length and max retraction speed. Retraction is mainly used to pull the filament back when the nozzle is traveling.

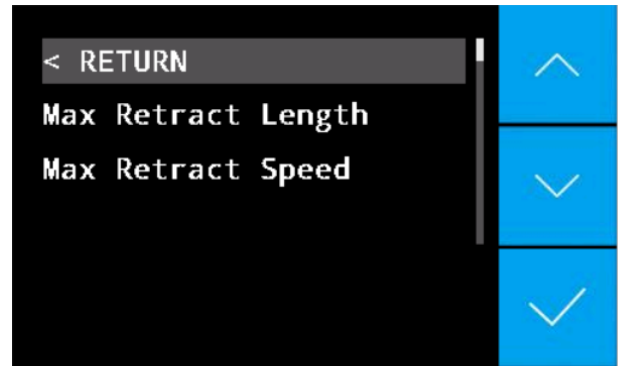

Figure 5.57

Extruder

This option is used to move the filament up or down.

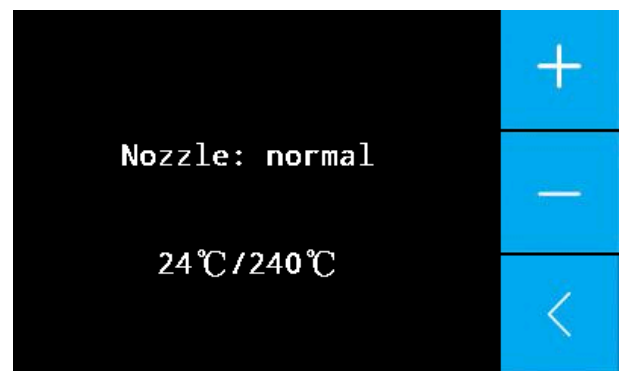

Figure 5.58

Motors Off

Select "Motors Off" to power off the stepper motors.

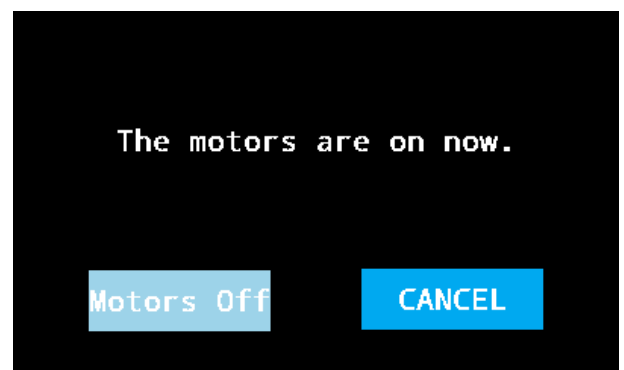

Figure 5.59

OTHER FUNCTIONS

Settings

In the settings section you have the option to change the temperature of the nozzle, the build plate, and the chamber, as well as the language & some additional parameters.

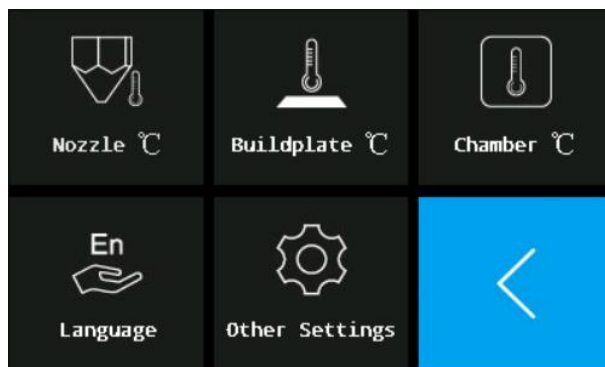

Figure 5.60

Nozzle Temperature

Increase or decrease the nozzle temperature. On this screen, you have desired temperature and actual temperature. You can modify the desired temperature here. Long press (+) / (-) or use the dial to modify the temperature.

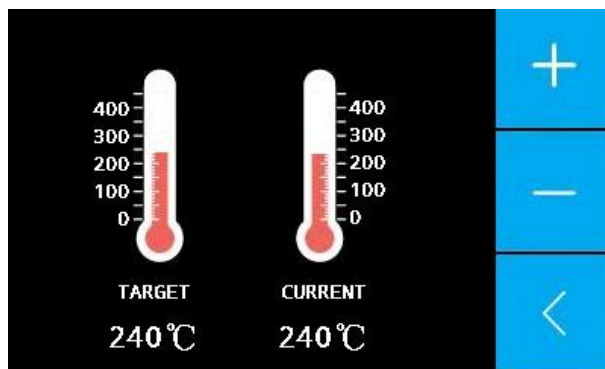

Figure 5.61

Build Plate Temperature

Increase or decrease build plate temperature. On this screen, you have desired temperature and actual temperature. You can modify the desired temperature here. Long press (+) / (-) or use the dial to modify the temperature.

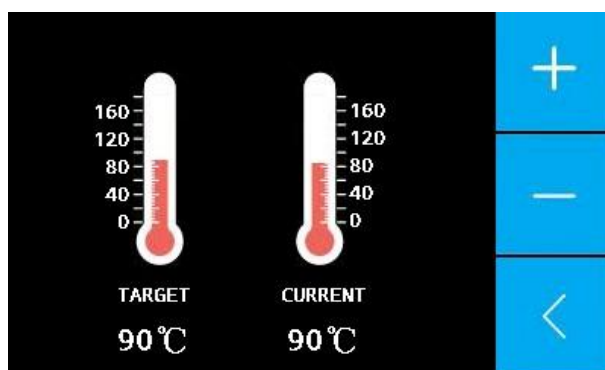

Figure 5.62

OTHER FUNCTIONS

Chamber Temperature

Increase or decrease chamber temperature. On this screen, you have desired temperature and actual temperature. You can modify the desired temperature here. Long press (+) / (-) or use the dial to modify the temperature.

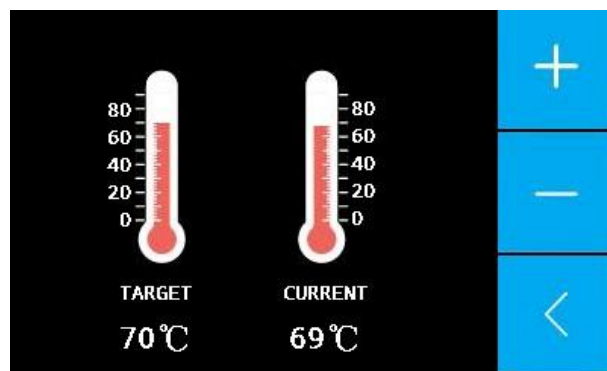

Figure 5.63

Language

Change the language.

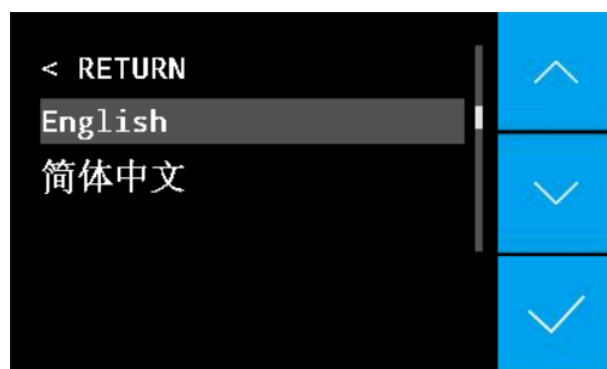

Figure 5.64

Other Settings

Change a few other parameters.

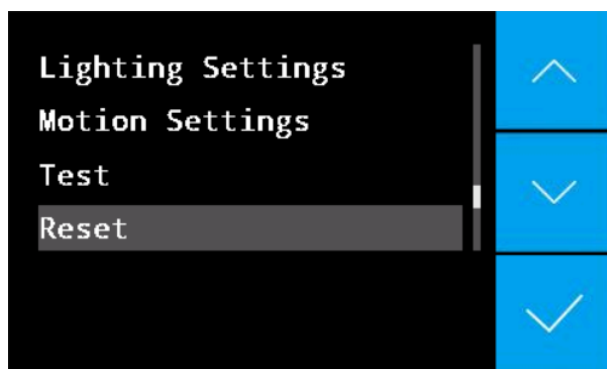

Figure 5.65

Help Section

This section provides some helpful information.

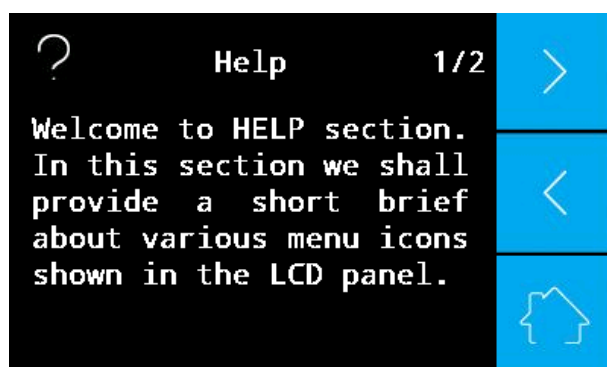

Figure 5.66

CHANGE NOZZLE SET

Change Nozzle Set

You will receive two nozzle sets with your printer. The one installed in the printer is the normal nozzle. It is designed for printing PLA, ABS, PC and materials with melting temperatures lower than 270°C. The other one has a max temperature of 450°C and is designed for printing high-temperature materials such as PEEK, Ultem and PPSU (the nozzle set with short wires in the adapter).

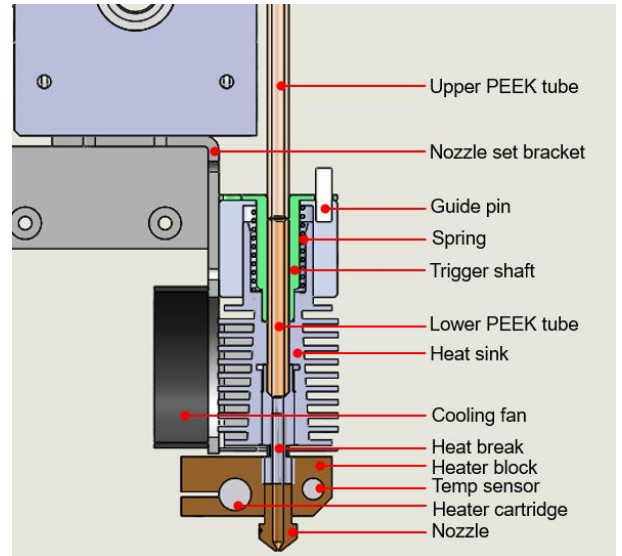

Figure 5.67

Step 1: To change the nozzle set, first, you need to remove all material from the nozzle. If the filament is stuck in the nozzle, you can increase the nozzle temperature manually and pull it out.

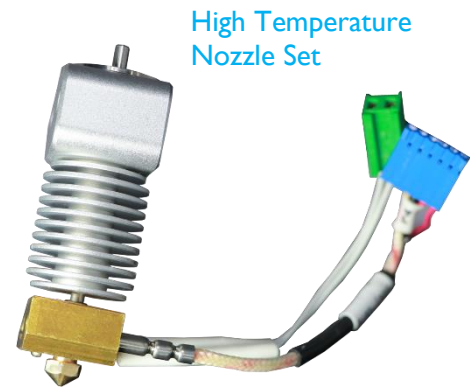

Figure 5.68

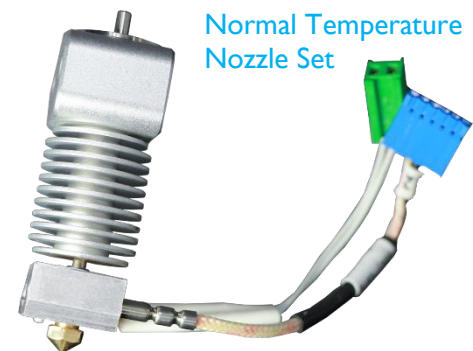

Figure 5.69

Step 2: Power off the machine and let the nozzle cool down to room temperature. Be careful with the HOT NOZZLE!

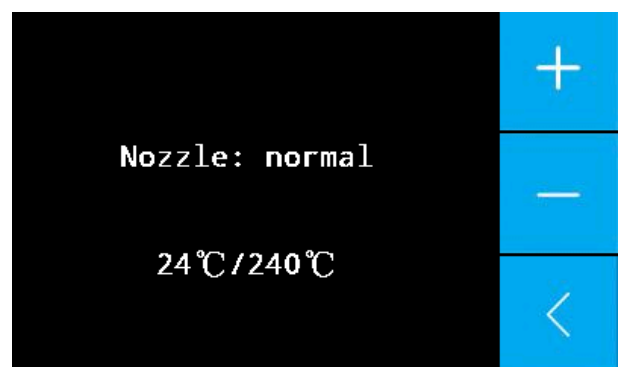

Figure 5.70

CHANGE NOZZLE SET

Step 3: Use the screwdriver to take out the screws fixed on the nozzle set cover and the nozzle set.

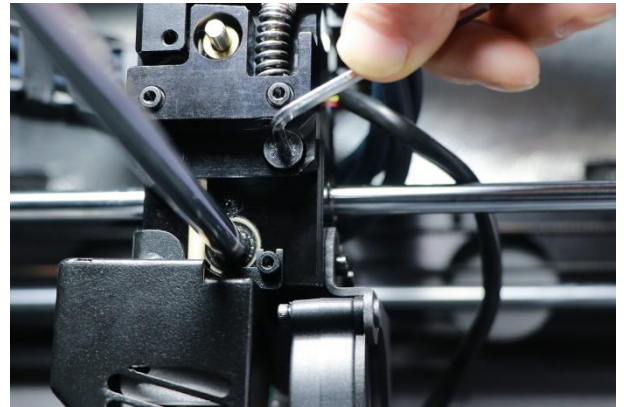

Figure 5.71

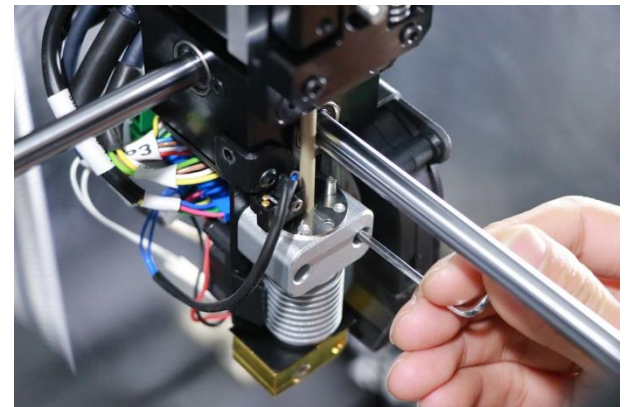

Figure 5.72

Step 4: Unplug the connectors (circled in the picture) behind the nozzle set. Be careful to pinch the buckles on the connectors when pulling them out.

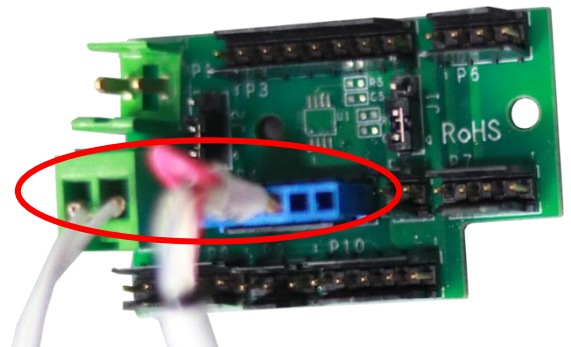

Figure 5.73

CHANGE NOZZLE SET

Step 5: Replace with the new nozzle set, ensure the upper PEEK tube is securely inserted into its position and the micro switch is just touch to the top surface of the nozzle set. Then plug the 6-pin connector into Pin Board's P4 and plug the 2-pin connector into Pin Board's P2.

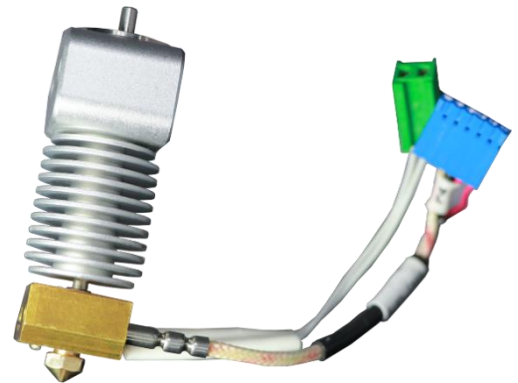

Figure 5.74

Step 6: Reassemble the screws you took out in the third step.

Step 7: Check the level sensor function, please follow step 1 in chapter “Auto Leveling”. If the level sensor can't be triggered or triggered without lifting the nozzle up, please repeat the step 5.

CHANGE NOZZLE ONLY

Change Nozzle Only

If you only want to change a nozzle, refer to the following steps.

Step 1: To exchange the nozzle, first you need to remove all material from the nozzle.



Figure 5.75

Step 2: Use the screwdriver to take out the screws fixed on the nozzle set cover.

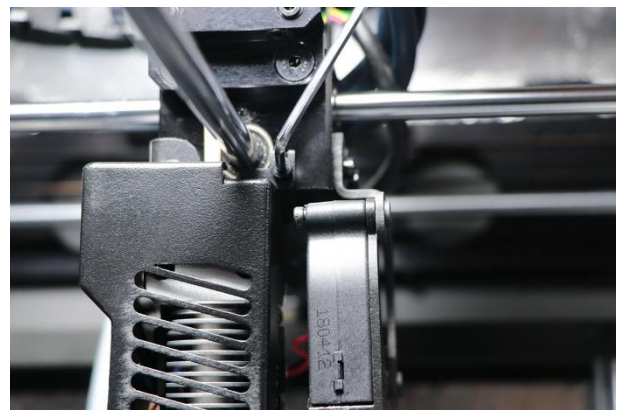

Figure 5.76

Step 3: Click “Extruder” button to heat the nozzle to the filament melting temperature. Then use the spanner to hold the heating block and the socket wrench to take out the old nozzle.



Figure 5.77

CHANGE NOZZLE ONLY

Step 4: Load filament to push the residual material in the break, and cut off the filament end. Then retract the filament. Note: If the Teflon tube is accidentally pushed out, remember to put it back.

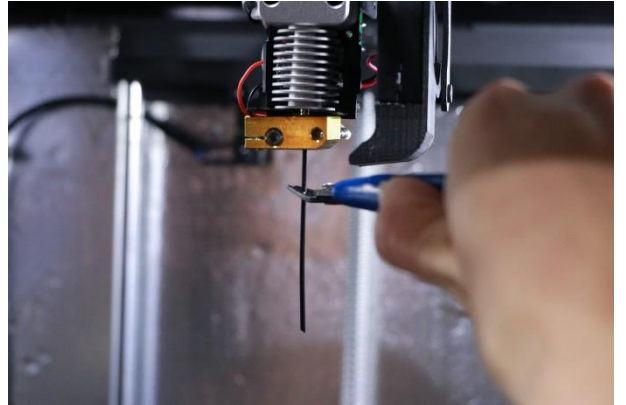

Figure 5.78

Step 5: Install the new nozzle and reassemble the nozzle set cover screws.

REMOVE PRINT & CLEAN SUPPORTS

Remove Print & Clean Supports

Once your 3D print is completed, it must be removed from the build plate when it is still in temperature maintain screen. Removing a print after it is cooling down may cause break of glass plate because the print may shrink more rapidly than the glass plate. Printer has a “Maintain Buildplate Temp” preset for every material to keep print part warm after printing finished.

Take out the glass and remove the print part as soon as possible. Also be careful with hot parts such as the chamber, platform, and nozzle. Use the putty knife provided with the printer to take the model out. And be careful not to damage the glass plate. Depending on your settings, you may need to remove the raft, brim, or support from the model. Use the cutting pliers and the tweezers provided to do so. If you have special requirements regarding the surface quality or the appearance of the printed object, you can use a metal file or sand paper to smooth it.



MAINTENANCE

It is extremely important that the FUNMAT HT is always maintained properly. In this chapter, you will find various steps for doing so.

UPDATING FIRMWARE

Updating Firmware

Periodically, a new version of the INTAMSYS firmware is released. To keep your INTAMSYS FUNMAT HT up to date it is recommended you update your firmware regularly. This can be done on the FUNMAT HT machine via USB.

Step 1: Download the new firmware file from <https://www.intamsys.com> or contact info@intamsys.com to get it.

Step 2: Put the firmware .hex files on your computer.

Step 3: Connect your computer and the printer via a USB Cable.

Step 4: Open the INTAMSUITE slicing software, Go to Settings -> Printers -> Upgrade Firmware.

Step 5: Select the firmware file for upgrading.

Step 6: After upgrading succeeds, remember to reset the firmware by clicking "Settings->Other Parameter->Reset".



Figure 6.1

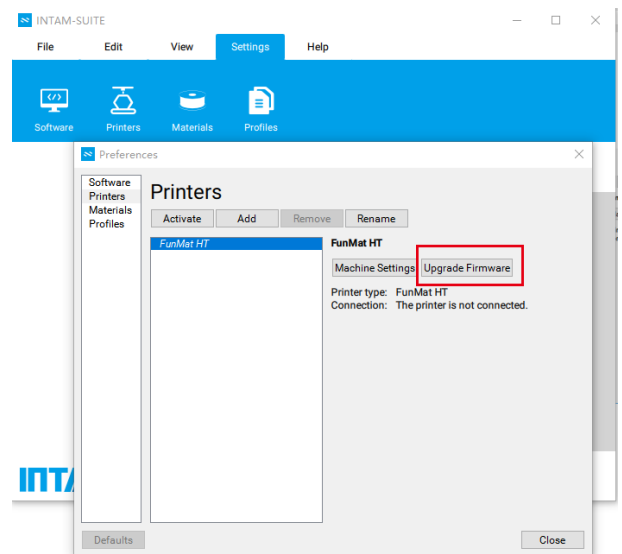

Figure 6.2

CLEANING THE GLASS PLATE

Cleaning the Glass Plate

After printing, excess glue that was used to stick the print on the build plate will accumulate on the build plate. This causes uneven print surfaces, which will negatively affect future prints. So, the glass plate has to be cleaned regularly.

Below are a few steps for cleaning the glass plate.

Step 1: Lower down the build plate by clicking “Settings” → “Other Settings” → “Buildplate to the bottom”.

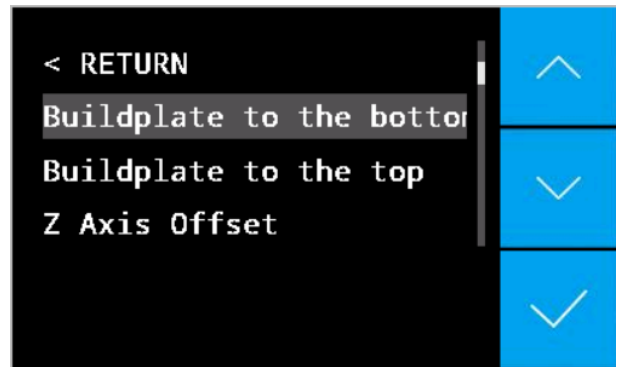

Figure 6.2

Step 2: Take your glass plate out.

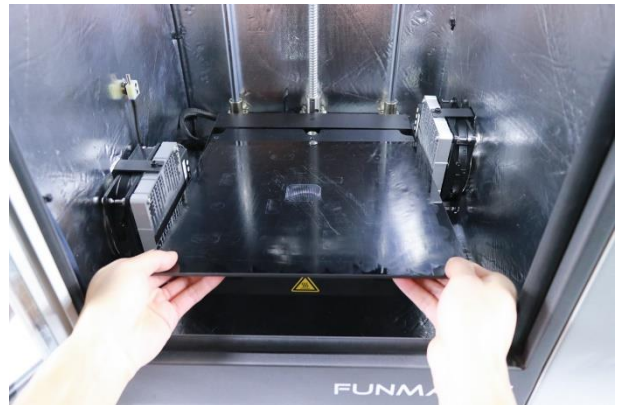

Figure 6.3

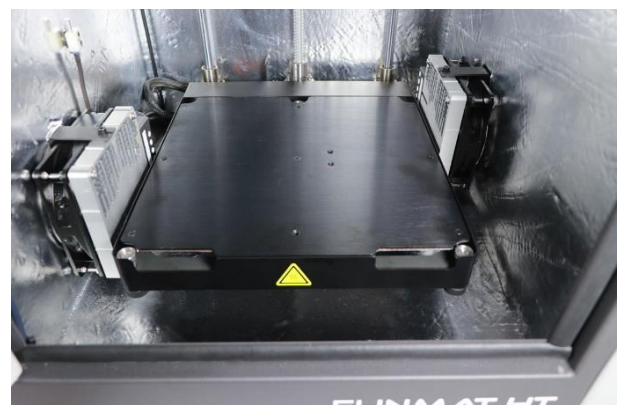

Figure 6.4

CLEANING THE GLASS PLATE

Step 3: Clean the glass plate with lukewarm water and dry it with a cloth. If necessary, you can also use a sponge and some soap.

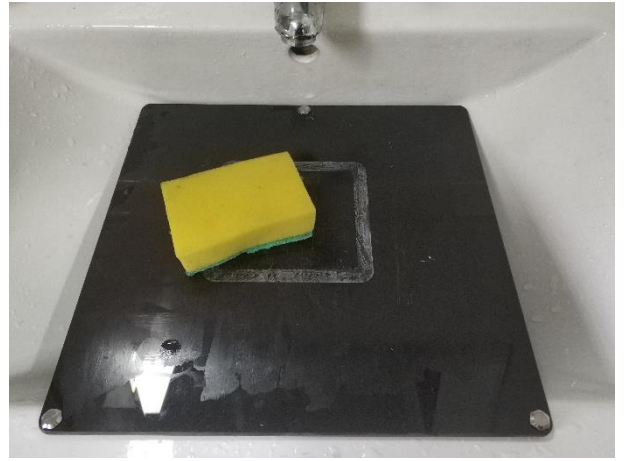

Figure 6.5

Step 4: Put the glass plate onto the platform. Align the three magnets on the glass plate to the magnet holders on the platform.

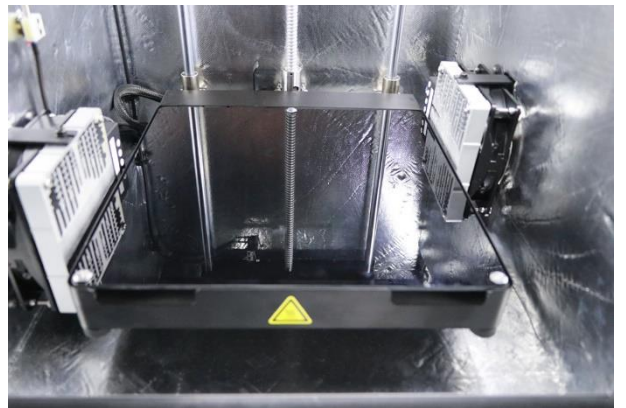

Figure 6.6

ADDITIONAL CLEANING

Cleaning Feeder

After repeated printing, small plastic particles can accumulate in the knurled wheel in the material feeder. These can be cleaned by blowing air on the knurl wheel or by using a simple brush. It is also recommended you clean the feeder if you notice grinding of the filament. Loosen the screw a little bit after completely tighten it, so that the pressing bar can move up and down smoothly.

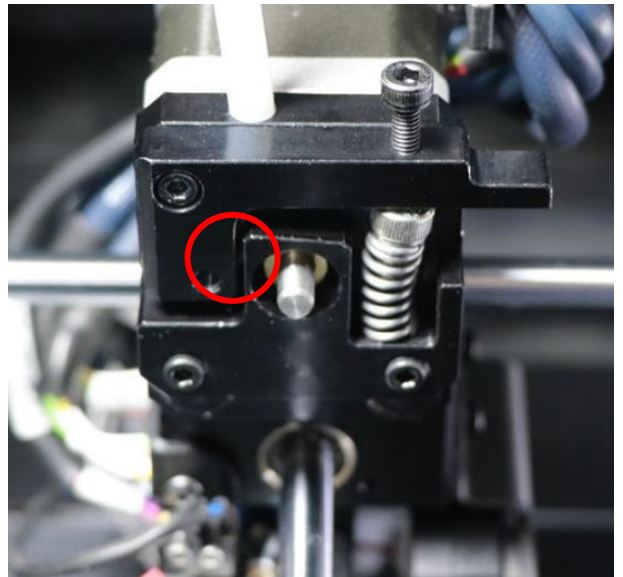

Figure 6.7

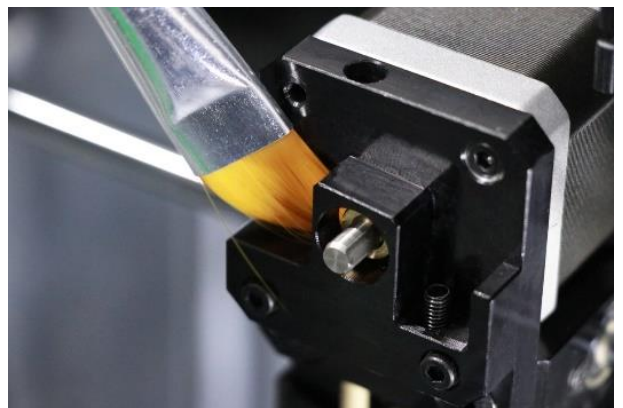

Figure 6.8

ADDITIONAL CLEANING

Cleaning Nozzle

While using the FUNMAT HT 3D printer, the nozzle can get dirty material sticking to it. This material doesn't damage the printer but it is recommended you keep the nozzle clean in order to achieve the best print results.

To remove the plastic from the outside the nozzle, take the following steps.

Step 1: Heat the nozzle up to the filament melting temperature so the plastic on the outside gets soft. You can do this by navigating to "Settings" then "Nozzle" and using the (+) / (-) buttons to change the temperature.

Step 2: When the nozzle is hot, carefully remove the material with tweezers.

⚠ Warning: Do not touch the hot nozzle and be careful while cleaning it.

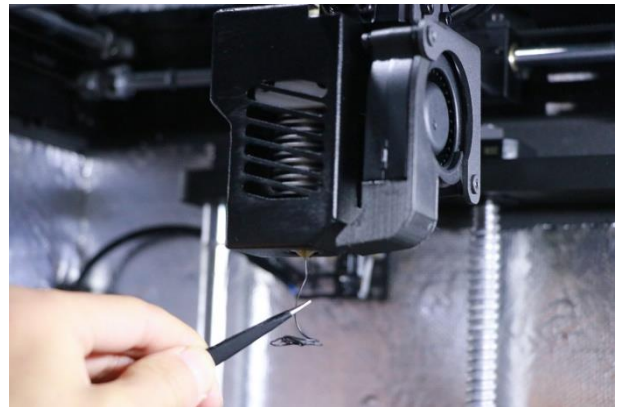

Figure 6.9

ADDITIONAL CLEANING

Lubricate Axis

When you notice small ridges on the surfaces of your 3D printed objects or feel that the X Y Z axes are dry, you should lubricate the X Y Z axes. This will help keep the printer running smoothly.

In general, we suggest you lubricate the X and Y axes after 200-300 hours of printing, or one week with heating chamber or two weeks without heating chamber.

We cannot ship the lubricating grease for logistical reasons. So, we recommend you buy the machine grease yourself. We recommend you use perfluoropolyether grease for the X Y Z axis guide rails.



Figure 6.10

Lubricate Guide Pin

When you notice big force is required to trigger the auto-level sensor during the “Leveling sensor” test in step one of Auto Leveling, you should lubricate the guide pin (refer to Figure 5.65). This will help keep the accuracy of auto leveling.

In general, we suggest you to lubricate the guide pin every one month.

We can't ship the lubricating grease for logistical reasons. So, we recommend you buy the machine grease yourself. We recommend you use perfluoropolyether grease for the guide pin.

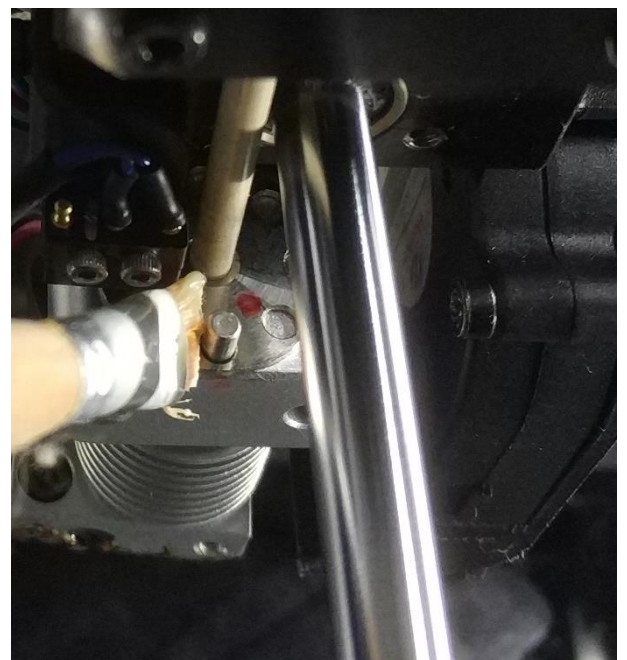

Figure 6.11

ADDITIONAL CLEANING

Filament Care

All filaments are highly sensitive to moisture. It is strongly recommended that filaments should be stored in a sealed container or bag with desiccant.

A dry box is recommended when printing.



Figure 6.12

If filament with moisture would result in foamy extrudate, stringing, underextrusion and rough surface. A convection oven can be used to dry filaments if residual moisture level is high.



Figure 6.13

Thread the filament into the small holes in the side of the spool after removing from the printer to avoid twisting. And ensure the filament is not twisted before printing.



Figure 6.14



TROUBLESHOOTING

In this chapter, you will find solutions to various frequently occurring problems with 3D Prints.

TROUBLESHOOTING

Note: We referred to www.3dverstan.se for this content as the common problems while printing are the same across different FDM 3D Printers.

Warping

Warping mainly happens with ABS. Warping happens when the plastic cools and contracts. As the print cools down and shrinks slightly, it starts to pull in on itself. Eventually, the forces become so great that the print bends up from the platform. The best solution to warping is a heated build platform. Another solution is to add glue to the platform to promote adhesion. Another option is to use BRIM / RAFT / SKIRT while printing the object. This option is available in CURA software.



Figure 7.1

Leaning

Leaning usually occurs when friction causes the print head to move a shorter distance than expected. To prevent leaning, make sure the moving parts of the printer don't rub against the main body of the printer.

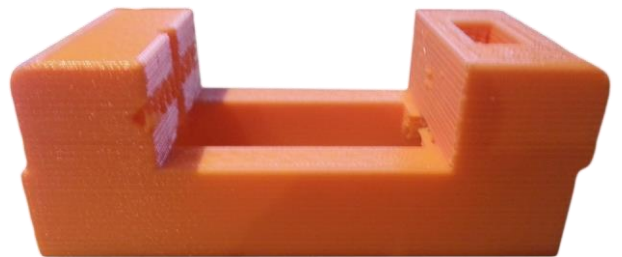

Figure 7.2

TROUBLESHOOTING

Shifted Layers

If a printer suddenly shifts the layers it is most likely because one or more pulleys are not secured properly to the axis/axes. Tighten the set screws that hold the pulleys in place very tightly. Another issue might be the head being too stiff. Add some sewing machine oil to solve this issue. Finally, check that the axis is perfectly aligned. If not, align the axis to be perfectly square.



Figure 7.3

Pillowing

Pillowing is bumps on the top surface of the print that can either be open or closed. When such an issue occurs, the most important thing to do is to make sure the cooling fans are at top speed when the printer is laying down the top layer. Without proper cooling, thin strands of plastic tend to curl up and stick up above the surface of the print and make it harder for the subsequent layers to properly span over the gap. Another solution is to print more layers for top and bottom parts, especially when layer height is very thin.



Figure 7.4

TROUBLESHOOTING

Circles Not Round / Lines Not Touching

When you are trying to print circles, it is possible they don't come out perfectly circular. This problem stems from backlash caused by slack belts. To solve this issue the belts should be tightened. To tighten the belts, loosen the stepper motor, pull it downward or upward to tighten the belt and then tighten the stepper motor screws.



Figure 7.5

Stringing

Stringing is the 'unwanted' thin strands of filament that connect parts of the printed object. The major countermeasure to solve stringing is retraction. Enable retraction and also increase the retraction length to prevent plastic from dripping from the nozzle while it moves. Another option is to increase the print speed, giving the head less time to ooze plastic. A third solution can be reducing the temperature. But, when reducing the temperature, make sure the printer is printing slowly to prevent under extrusion.



Figure 7.6

TROUBLESHOOTING

First layer not sticking / Parts coming loose

The most common cause of this problem is improper leveling of the build plate. It is very important that the build plate is perfectly leveled in relation to the movement of the print head and that the distance between the nozzle and the plate is as close to perfect as possible.

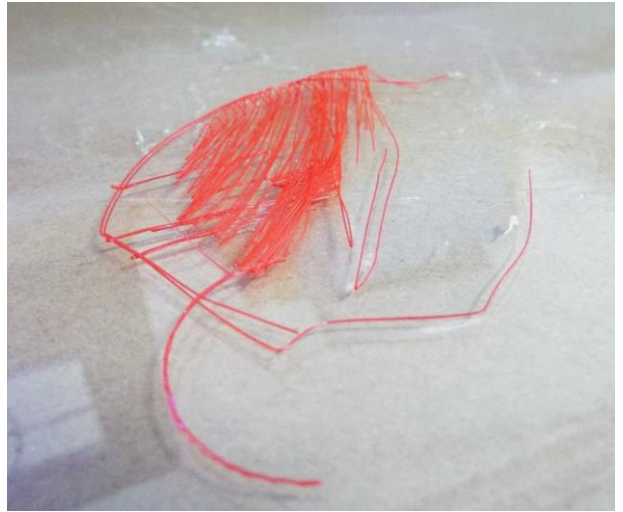

Figure 7.7

Grinding

Grinding happens when the motor tries to push filament through the nozzle but, for various reasons, it starts to slip on the filament and instead grinds the plastic down. The more it grinds the filament, the less grip it is able to get and eventually it is not able to move the filament in or out.

One source of this issue may be the retraction speed being too fast. Try reducing retraction speed by 50%. Another solution may be to increase extruder temperature by 5-10°C. Finally, you can try reducing the printing speed to solve this issue.



Figure 7.8

Tangled Filament

A tangled filament can cause numerous printing problems. Make sure the filament can unspool unhindered.

TROUBLESHOOTING

Feeder Pressure

The amount of pressure the feeder puts on the filament is adjustable. This pressure should be adjusted to the optimal level to prevent filament grinding. To adjust feeder pressure, tighten or loosen the screw above the feeder.

Under Extrusion

Under-extrusion is when the printer can't supply the amount of plastic. Symptoms of this are missing layers, very thin layers or layers that have random dots and holes in them. If you are experiencing under- extrusion, first make sure the diameter of your filament matches the diameter of your nozzle. If it does, you can try increasing your flow rate by around 5%.

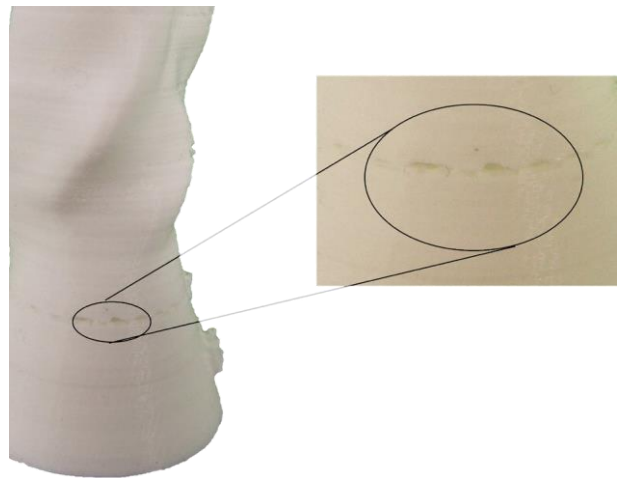

Figure 7.9

Layer separation and splitting

One major reason for layer separation and splitting is the layer height being too large. As a rule of thumb, layer height should be at most 80% of the nozzle diameter, i.e., if you are using 0.40 mm nozzle, layer height should not be greater than 0.32 mm. Another reason for layer separation and splitting is the print temperature being too low. Warm plastic always bonds together much better than cold plastic, so increasing the nozzle temperature may solve layer separation and splitting.



Figure 7.10

TROUBLESHOOTING

Nozzle Clogged

If the material can not come out of the nozzle, one major cause might be the nozzle being clogged. This happens when the nozzle temperature is much higher than the material melting point, or when the nozzle temperature is much lower than the material melting point. If the nozzle temperature is much higher, the filament gets carbonized, leading to nozzle clogging. If the nozzle temperature is lower, the filament does not melt enough to be extruded out of the nozzle. Another cause can be the distance between the nozzle and the build plate. If the nozzle is too close, the filament will be obstructed from coming out of the nozzle. In such a case, you should re-level the bed.



SOFTWARE OVERVIEW

This section contains details about the INTAM-suite slicing engine developed in-house by INTAMSYS, based on the open source slicing software CURA.

ABOUT SOFTWARE

About Software

INTAM-suite is a slicing software based on Cura. In order to print your objects with a 3D Printer, first, you will need to use a slicing software to convert your STL file into GCode. Once you convert to GCode, you can load your file into the printer and start printing.

Download and install software

Step 1: You can download the software from the SD card provided with your printer. It is also available on our website: www.INTAMSYS.com. Follow the instructions to complete the installation.

Step 2: Double click the software on the SD card provided.

Step 3: Choose the destination folder where you want to install INTAMSUITE and click "Next"

 IntamSuite-3.4.0-win64.exe

Figure 8.1

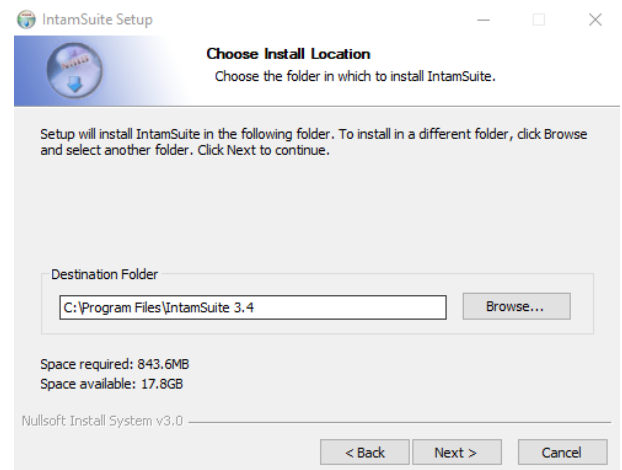

Figure 8.2

DOWNLOAD AND INSTALL SOFTWARE

Step 4: Choose all the components you wish to install with INTAMSUITE and click “Install.”

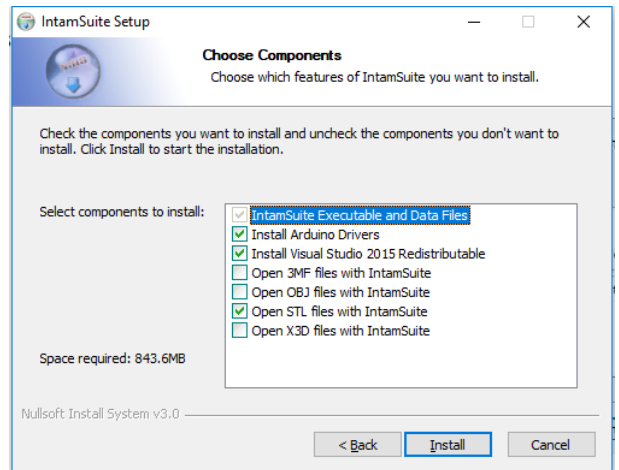

Figure 8.3

Step 5: Wait a moment for the program to install the software.

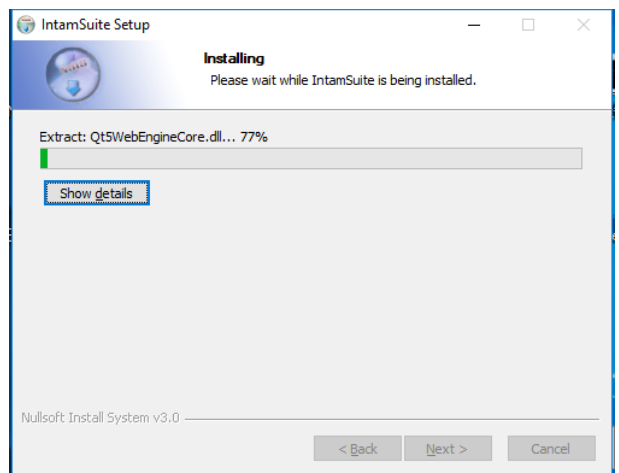

Figure 8.4

Step 6: INTAM-suite is ready to use!

Step 7: Click "Finish."

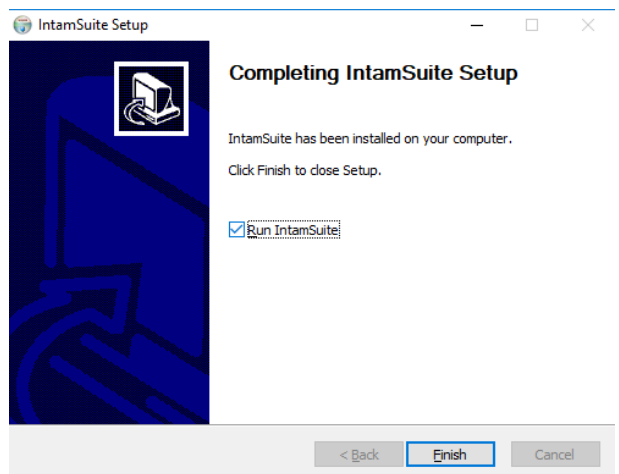

Figure 8.5

DOWNLOAD AND INSTALL SOFTWARE

Step 8: Select the model of your printer and click "Add Printer", you are now ready to use INTAM-Suite with your machine type!

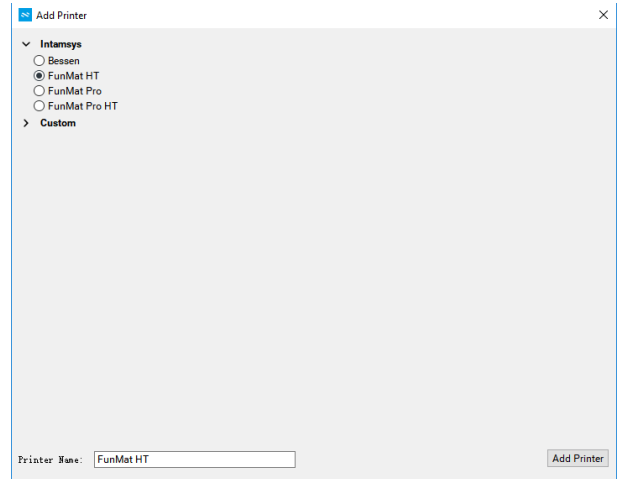

Figure 8.6

OVERVIEW OF VARIOUS SCREENS

Overview of Various Screens

File Screen

On this screen you can perform regular operations like OPEN file, Save G-Code, etc.

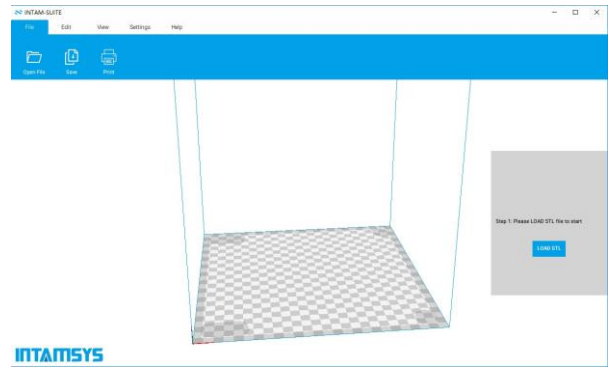

Figure 8.7

Edit Screen

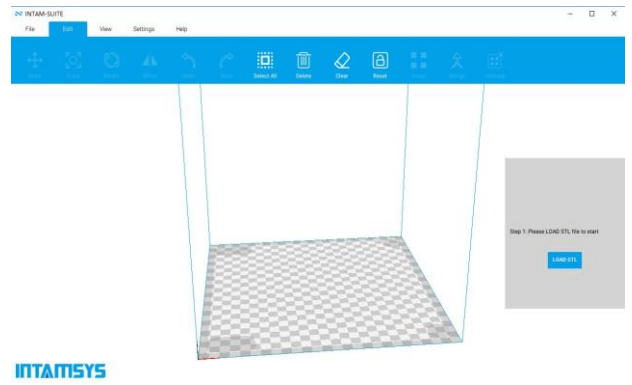

Figure 8.8

View Screen

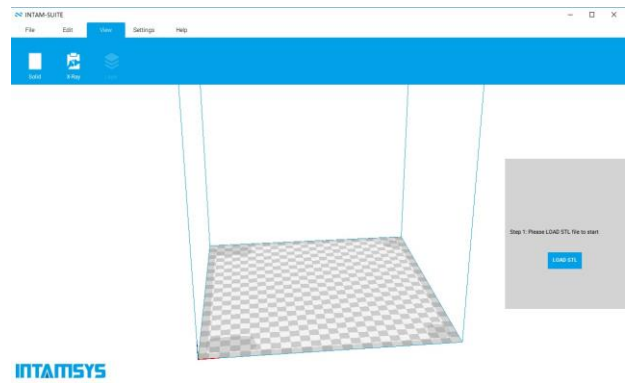

Figure 8.9

OVERVIEW OF VARIOUS SCREENS

Settings Screen

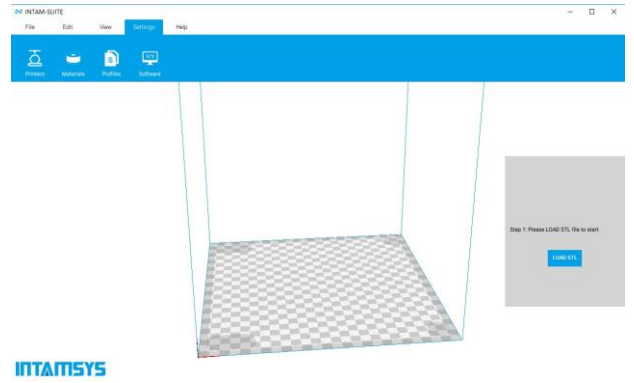

Figure 8.10

Help Screen

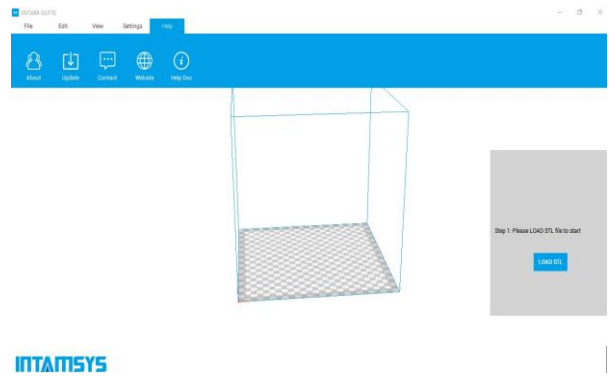

Figure 8.11

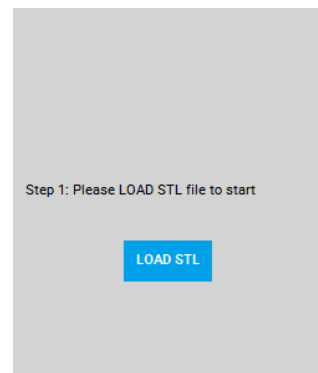

Figure 8.12

USING SOFTWARE

Using Software

Step 1: Load STL.

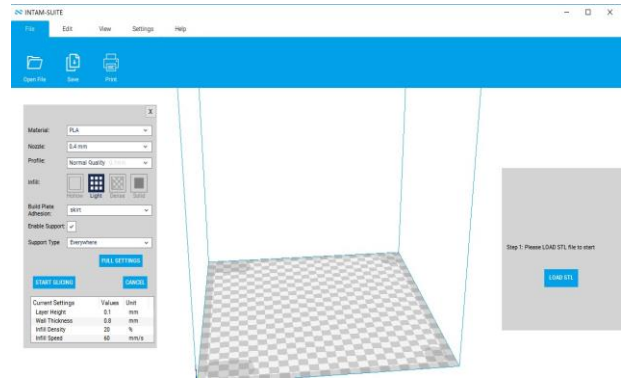

Figure 8.13

Step 2: Edit STL

Make sure your object is laid flat on the platform. You can use the Rotate, Scale and Mirror buttons in the bottom-left corner to modify your objects. The viewing button is located in the top-right corner. You can change the viewing mode to get a better view of the objects.

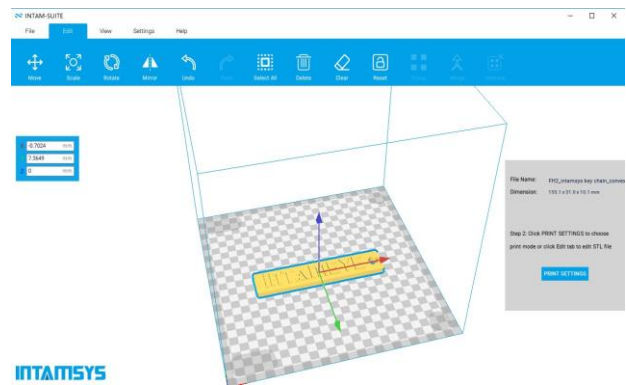

Figure 8.14

Step 3: Print STL

After you finish modifying your file, the next step is to pick the profile setting based on your requirements. Fast print provides a relatively rough quality but requires less time to print. Normal, high, and ultra will provide better and better quality but have slower and slower printing speeds. You can also choose the specific type of material you want to print, the nozzle size, support type, and platform adhesion type.

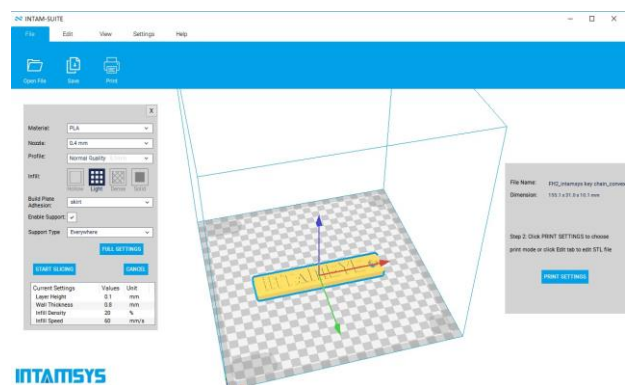

Figure 8.15

USING SOFTWARE

If you would like to customize the print settings or you have special requirements for the print, you can go to “full settings” by clicking the “switch to full settings” option in the Expert menu. On this page, you can modify each print setting yourself. If you are a professional 3d printer user, there are more setting options available for you in the expert settings. You can go to expert settings by clicking the “open expert settings” option in the Expert menu.

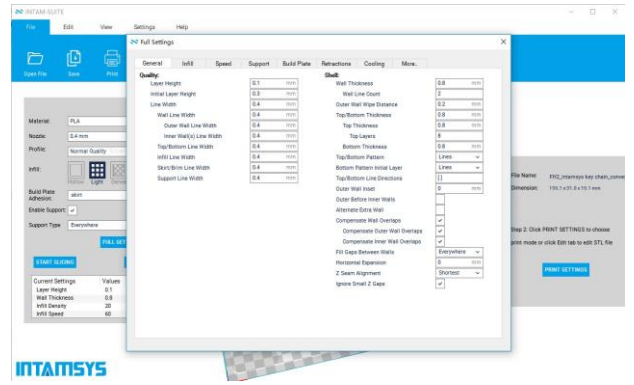

Figure 8.16

Step 4: Save to G-Code.

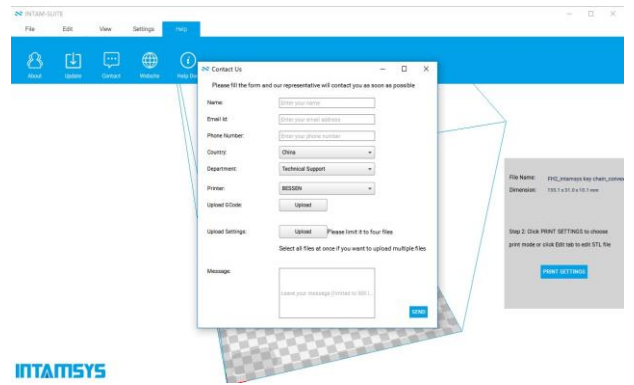

Figure 8.17



GLOSSARY

In this section, you can find definitions for various regularly used 3D Printing related terms.

GLOSSARY

Terminology	Definition
Numerical	
3Doodler	A kind of 3D Pen that can be used to draw three-dimensional objects.
3D Bioplotter	Well reputed 3D Bio-Printing machine from Envision-tec.
3D Bio-Printing	The process of creating cell patterns in a confined space using 3D printing technologies, where cell function and viability are preserved within the printed construct.
3D Model	A three-dimensional design usually produced using various 3D modeling software's like CATIA, CREO, SOLIDWORKS.
3D Printing	Process of creating a three-dimensional object by depositing material layer by layer.
3D Sand Casting	A metal casting process characterized by using sand as the mold material.
3D Scan	A process by which the shape and texture of a real world object is captured and displayed as a 3D Model.
3D Systems	Well known 3D Printing company founded by the inventor of 3D Printing technology.
A	
ABS: Acrylonitrile Butadiene styrene	A popular thermoplastic material heavily used in 3D Printing.
ABS Glue	Made by adding a bit of acetone to the ABS filament. This is used to stick the 3D Print to the build plate.
Acetone	An organic solvent used to dissolve left over filament in a nozzle to unclog the nozzle and also for smoothing the ABS printed object surface.
Additive Manufacturing	Process of creating a three-dimensional object by depositing material layer by layer.
All Metal Hot End	A nozzle design that can go up to temperatures of 400°C.
Alumide	A material used in 3D printing consisting of nylon filled with aluminum dust. Its name is a combination of the words aluminum and polyamide. The printed objects have a metallic look.

GLOSSARY

Terminology	Definition
AMF	Additive Manufacturing File Format is an open standard for describing objects for additive manufacturing processes such as 3D printing.
Amorphous	Without a clearly defined shape or form.
Anisotropic	Object with physical properties that are different in different directions.
B	
Bed	Platform on which material gets extruded.
Binder Jetting	A 3D Printing process where binder is jetted after each layer to glue it to the next layer.
Biopolymer	Polymers produced by living organisms. Since they are polymers, biopolymers contain monomeric units that are covalently bonded to form larger structures.
Blender	An open source 3D modeling software.
Bridges	Printing horizontal layers in the air without support. To achieve good quality for bridges, it is recommend to reduce printing speed and printing temperature.
Brim	Attached to a model and extends outward. Brims typically have several outlines and may be a few layers tall. Brims are often used to stabilize small parts of a model, such as legs of a table, because brims help these areas stay connected to the print bed.
Build Plate	The platform on which material is deposited layer by layer.
Build Platform	Same as build plate.
Build Time	Time it takes to print the object as per the parameters defined in slicer software.
Build Volume	Build volume = Printer Length x Printer Width x Printer Height.
Build TAK	A sheet that is placed on the build plate before extruding the material to avoid warping of printed objects.
C	
CAD / CAM	Computer Aided Design / Computer Aided Machining.
CAE	Computer-aided engineering is the broad usage of computer software to aid in engineering analysis tasks like Finite Element Analysis.

GLOSSARY

Terminology	Definition
Catia	Popular 3D Modeling software.
CJP : Color-Jet-Printing	A type of 3D Printing technology from 3D Systems, primarily for printing multi-color objects.
CLIP	Continuous Liquid Interface Production.
CNC Machining	A process used in the manufacturing sector that involves the use of computers to control machine tools.
Crystalline	A crystal or crystalline solid is a solid material whose constituents are arranged in a highly ordered macroscopic structure, forming a crystal lattice that extends in all directions.
Curing	A process of hardening photopolymers through UV light.
D	
DLP : Digital Light Processing	A type of 3D Printing technology where photopolymers are cured using UV light.
DMLS: Direct Metal Laser Sintering	A type of 3D Printing technology.
E	
EBM: Electron Beam Melting	A type of 3D Printing technology which uses an electron beam instead of a laser or thermal printhead. EBM is often used for the production of incredibly dense metal parts.
End Stop	3D Printer axes all need a datum (also known as home position or end-stop) to reference their movements.
EOS	Industrial 3D Printing company well known for its metal 3D Printing.
Extruder	A device that sends a certain amount of filament to the hot end.
F	
FabLab	A small-scale workshop for digital fabrication.
FDM: Fused Deposition Modeling	A type of 3D Printing technology that uses heat to melt and extrude plastic filament onto the build plate.
Filament	Plastic wires used in FDM 3D Printing.

GLOSSARY

Terminology	Definition
Fixture	Used to hold a workpiece during either a machining operation or some other industrial process.
Flowrate	The volume of fluid that passes per unit time.
G	
G-Code	The common name for the most widely used numerical control (NC) programming language. It is used mainly in computer-aided manufacturing to control automated machine tools.
Glass Transition Temperature	Glass Transition Temperature (T_g) is the temperature region where the polymer transitions from a hard, glassy material to a soft, rubbery material.
H	
Hardening	Harden (make an object tougher) generally by using heat treatment.
Heated Bed	Heated build platform (also called heated bed) improves printing quality by helping to prevent warping. As extruded plastic cools, it shrinks slightly. Heated beds usually yield higher quality finished builds with materials such as ABS and PLA.
Heated Build Chamber	Heated build chamber also improves the printing quality by maintaining the constant temperature in the chamber thereby avoiding cracks.
HIPS	High Impact Polystyrene is a type of 3D Printing filament.
Hot End	The device that melts the filament and extrudes the molten filament onto the build plate.
Hydrogel	A network of polymer chains that are hydrophilic. Hydrogels are highly absorbent natural or synthetic polymeric networks.
I	
Infill	Material that is used to fill in gaps/holes.
Injection Molding	The plastic injection molding process produces large numbers of parts of high quality with great accuracy, very quickly.
Inkjet Bioprinting	The process of printing tissues through a jetting process similar to 2D Printing where a combination of hydrogel and cells are jetted into a scaffold as per a predetermined model.

GLOSSARY

Terminology	Definition
Isotropic	An object having a physical property which has the same value when measured in different directions.
J	
Jig	Used to hold and guide a workpiece during either a machining operation or some other industrial process.
K	
Kapton Tape	A kind of tape used to avoid product warping during the printing process, especially for ABS material.
L	
Layer Height/Slice Thickness	Height of each layer that gets deposited on the build plate.
Layer Thickness	Same as layer height/slice thickness.
Layout	The way in which the parts of something are arranged or laid out.
LCF : Laser Cladding Forming	A type of additive manufacturing technology. During the process of laser cladding forming, a high power laser beam is focused onto the substrate to create a molten pool. Metal powders are simultaneously injected into the focal zone by the powder delivering nozzles and then melted and rapidly solidified.
LENS: Laser Engineered Net Shaping	An additive manufacturing technology developed for fabricating metal parts directly from CAD model using metal powder injected into a molten pool created by a focused, high-powered laser beam.
Linear Guide	Used for movement across an axis (X, Y, and Z). Meant for higher accuracy.
Linear Rail	Used for movement across an axis (X, Y, and Z).
LOM: Laminated Object Machining	An RP system where layers of adhesive-coated paper is used to build a 3D model.
M	
Melting Point	The temperature at which a given solid will melt.
Metal Powder	Generally used in Metal Laser Sintering.
Micron	A unit of measurement, 0.001 mm. Also known as a micrometer.

GLOSSARY

Terminology	Definition
MJF : Multi-Jet-Fusion	Proprietary 3D Printing technology developed by HP.
MJP : Multi-Jet Printing	Another term for Poly Jet Printing.
Monomer	A molecule that can be bonded to other identical molecules to form a polymer.
N	
NEMA	National Electrical Manufacturers Association offers standards for various products like Stepper Motors.
Nozzle	The metal tip where plastic material gets melted and extruded.
Nozzle Diameter	Diameter of the nozzle from where material gets extruded.
NPJ: Nano Particle Jetting	A metal inkjet 3D Printing process where nanoparticles suspended in liquid are jetted and later sintered.
Nylon	Kind of synthetic polymers that can be melt-processed into fibers, films or shapes.
O	
OBJ	A kind of 3D Printing file format.
Open SCAD	Software for creating solid 3D CAD objects.
Organovo	Calls itself a regenerative medicine company.
Overhang	A part of something that extends or hangs over something else. Supports are used to print overhangs.
P	
PC	Polycarbonates are a group of thermoplastic polymers containing carbonate groups in their chemical structures. Polycarbonates are used in engineering applications.
PEEK	Polyether ether ketone (PEEK) is a colorless organic thermoplastic polymer in the polyaryletherketone (PAEK) family, used in engineering applications.
PET	Polyethylene terephthalate, commonly abbreviated PET is the most common thermoplastic polymer resin of the polyester family.
Photopolymerization	Process of changing the properties of photopolymer by exposing it to light.

GLOSSARY

Terminology	Definition
PJP: Polyjet Printing	PolyJet 3D Printing works similarly to inkjet printing, but instead of jetting drops of ink onto paper, PolyJet 3D Printers jet layers of curable liquid photopolymer.
PLA	Polylactic Acid is a type of 3D Printing filament made out of corn starch.
PlasticJet Printing	Similar to FDM/FFF.
Polyamide	A synthetic polymer made by the linkage of an amino group of one molecule and a carboxylic acid group of another, including many synthetic fibers such as nylon.
Polyphenylsulfone (PPSF)	Polyphenylsulfone (PPSF or PPSU) is a type of high-performance polymer usually consisting of aromatic rings linked by sulfone (SO ₂) groups.
Post Processing	A set of processes used to smooth out the 3D Printed object.
PP : Plaster-based 3D printing	3D Printing using sandstone or plaster as the input material. This is popular for creation of miniatures.
PP : Polypropylene	Polypropylene (PP), also known as polypropene, is a thermoplastic polymer used in a wide variety of applications including packaging and labeling.
Printing Resolution	Layer height in micrometers at which 3D Printing happens.
Printing Speed	The speed at which the hot end moves while extruding the filament.
PTFE	Polytetrafluoroethylene (PTFE) is a synthetic fluoropolymer of tetrafluoroethylene used for multiple applications.
PVA	Polyvinyl alcohol is a water-soluble synthetic polymer.
Q	
R	
Raft	A horizontal latticework of filament that is located underneath your part. Rafts are primarily used with ABS to help with bed adhesion. Rafts are also used to help stabilize models with small footprints, or to create a strong foundation on which to build the upper layers of your part.
RAMPS	RepRap Arduino Mega Pololu Shield.
Rapid Prototyping	A set of techniques used to quickly fabricate a scale model of a physical part or assembly using three-dimensional computer aided design (CAD) data.

GLOSSARY

Terminology	Definition
RepRap	Open source rapid prototyping system that is capable of producing its own parts and can be replicated easily.
Resin	A solid or liquid synthetic organic polymer used as the basis of plastics, adhesives, varnishes, or other products.
Resolution	Layer thickness usually defined in micrometers.
Rhinoceros	A commercial 3D computer graphics and computer-aided design application software.
S	
Sculptris	Well known 3D modeling software used for sculpting.
SDL: Selective Deposition Lamination	Selective Deposition Lamination is a 3D printing process using paper.
Shells	Represents an outer wall of a 3D Print.
Sintering	Join powder into a solid porous mass by heating.
Sketchup	Well known 3D modeling software.
Skirt	An outline that surrounds your part but does not touch the part. The skirt is extruded on the print bed before starting to print the model. Skirts serve a useful purpose because they help prime the extruder and establish a smooth flow of filament.
SLA: Stereolithography	A type of 3D Printing process where a laser is used to cure a tank of liquid resin.
Slicing	Process of dividing a 3D model into multiple layers for printing.
SLM: Selective Laser Melting	A rapid prototyping technique designed to use a high power laser to melt and fuse metallic powders together.
SLS : Selective Laser Sintering	A type of 3D Printing process where a laser is used to sinter powder particles.
SolidWorks	Well known 3D modeling software.
Steel 3D printing	3D Printing of Steel powder.

GLOSSARY

Terminology	Definition
Stepper Motor	A brushless DC electric motor that divides a full rotation into a number of equal steps. The motor's position can then be commanded to move and hold at one of these steps without any feedback sensor (an open-loop controller), as long as the motor is carefully sized to the application.
STL	Stereolithography is a file format native to the stereolithography CAD software created by 3D Systems. It is well-known file format for 3D Printing.
Support Material	Used to hold the suspended parts of a 3D Printed object.
Supports	Supports are used when models have steep overhangs or unsupported areas.
Surface Finish	Surface finish, also known as surface texture, is the characteristics of a surface. It has three components: lay, surface roughness, and waviness.
SVG (Scalable Vector Graphics)	An XML-based vector image format for two-dimensional graphics with support for interactivity and animation.
T	
Tank (Resin)	A holder of resin in SLA / DLP 3D Printing.
Tensile Strength	The strength of material expressed as the greatest longitudinal stress it can bear without tearing apart.
Thermoplastic	Having the property of softening or fusing when heated and of hardening and becoming rigid again when cooled.
Tissue Engineering	The use of a combination of cells, engineering and materials methods, and suitable biochemical and physiochemical factors to improve or replace biological tissues.
Titanium 3D Printing	3D Printing using Titanium powder.
TPP :Two-Photon-polymerization	A new approach to micromachining and can be considered the next level to SLA. Very precise 3D models can be created within a very short span of time.
Triple Jetting	A Stratasys process where 3D Printers also jet a gel-like support material specially formulated to uphold overhangs and complex geometries during the printing process.
U	

GLOSSARY

Terminology	Definition
Ultem	Polyetherimide is an amorphous, amber-to-transparent thermoplastic with characteristics similar to PEEK.
UV Light	Ultraviolet is an electromagnetic radiation with a wavelength from 10 nm (30 PHz) to 400 nm (750 THz) generally used for curing in DLP process.
V	
VAT	A large open vessel for holding or storing liquids. In 3D Printing, generally for holding resin in DLP or SLA process.
W	
Wall Thickness	Thickness of the wall or the outer part of the 3D object.
Warping	Bending of an object on the edges due to material shrinkage while 3D Printing.
X	
X-Axis	X-Axis of a 3D Printer.
Y	
Y-Axis	Y-Axis of a 3D Printer.
Yield	Stress at which material starts deforming plastically.
Young's Modulus	Stress/strain. It is a measure of the stiffness of a solid material.
Z	
Z-Axis	Z-Axis of a 3D Printer.

INTAMSYS

INTAMSYS TECHNOLOGY CO., LTD.

www.intamsys.com 021-5846 5932

info@intamsys.com

3rd Floor, Building C9, No. 3188 Xiupu Road, Pudong
New District, Shanghai, P.R.China 201315