

Specifications

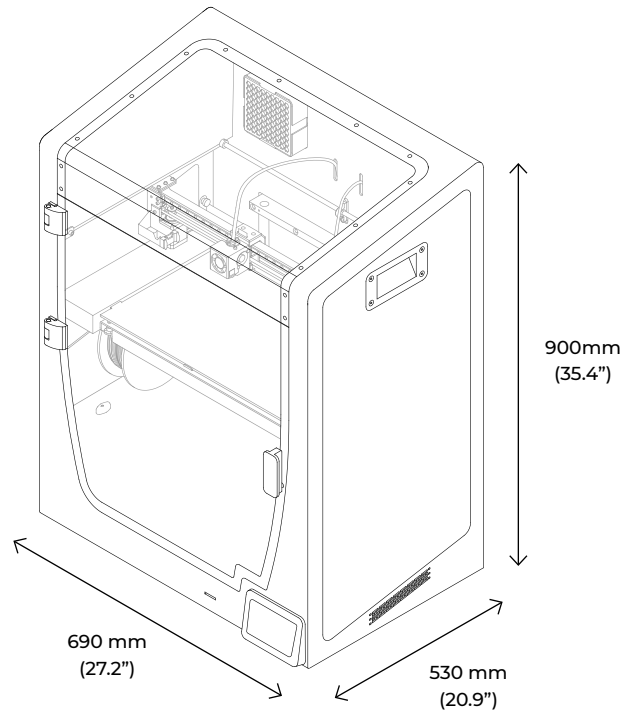

BCN3D Epsilon W50

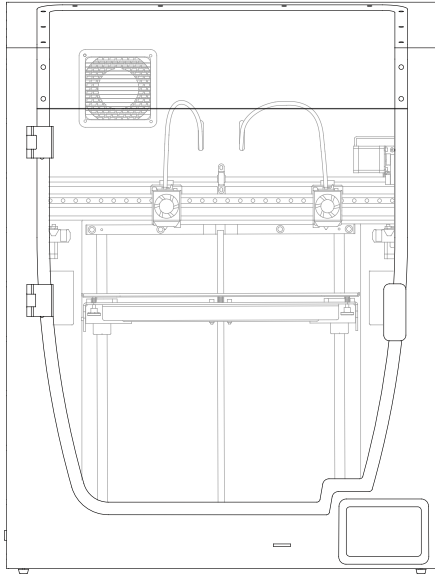

Printer properties

3D Printing Technology	Fused Filament Fabrication (FFF)
Architecture	Independent Dual EXtruder (IDEX)
Printing volume	420mm x 300mm x 400mm (16.5" x 11.8" x 15.8")
Build chamber	Passive Heated Chamber Fully enclosed Safety Pause
Air filtering	Category H13 HEPA filter Active Carbon filter
Number of extruders	2
Warranty	2 years for EU countries 1 year for non-EU countries
Extruder system	Extruder Bondtech™ high-tech dual drive gears Hotends optimized
Printing modes	Single mode Duplication mode Mirror mode Multimaterial mode Soluble Supports mode

Specifications



BCN3D Epsilon W50

Printer properties

Calibration system	Based on a piezoelectric sensor Main features: * Accurate Z homing * Quick assisted bed leveling * Automatic XYZ offset extruder calibration * Automatic Mesh Mapping
Electronics	Single Board Computer: Toradex ARM Compute Module Motion Board: BCN3D Electronics with Independent Stepper Drivers
Firmware	BCN3D Embedded Linux distribution BCN3D Epsilon - Marlin
Heated bed	Silicone thermal pad
Screen	5" full color capacitive touchscreen
Supported languages	Spanish English German French Italian Japanese Portuguese Chinese
Supported files	*.gcode
Operating sound	49 dB(A)
Nozzle diameter	Brass nozzle: 0,4mm (default) 0,6mm 0,8mm 1,0mm Hotend X: 0,6mm - Hotend M: 0,4mm
Certifications	CE / FCC
Connectivity	Offline printing: SD card Online printing: WiFi or Ethernet (through BCN3D Cloud)

Materials

Filament diameter	2,85 ± 0,05 mm
Compatible materials	Standard materials: PLA, Tough PLA, PET-G, TPU 98A, PVA, BVOH Technical materials: ABS, PP, PA Composite materials (only with Hotend X): PP GF30, PAHT CF15, PET CF15 Metal materials (only with Hotend M): Ultrafuse 316L, Ultrafuse 17-4 PH
Open filament system	Yes

Specifications



BCN3D Epsilon W50

Physical properties

Overall dimensions	690mm (W) x 530mm (D) x 900mm (H) (27.2" x 20.9" x 35.4")
Weight	37kg (81.6 lb)
Shipping box dimensions	800mm (W) x 600mm (D) x 1370mm (H) (31.5" x 23.6" x 53.9")
Shipping weight	62kg (136.7 lb)
Shipping method	Half Europallet

Printing properties

Recommended profiles	Layer height: 0,2mm 0,3mm 0,4mm (depending on nozzle diameter)
Layer height	0,05mm - 0,5mm (custom profiles)
Positioning resolution (X / Y / Z)	1,25µm / 1,25µm / 1µm
Operating temperature	15 °C - 30 °C
Extruder maximum temperature	300 °C
Heated bed maximum temperature	120 °C
Build chamber maximum temperature	60 °C (depending on operating temperature)

Electric Properties

Input	AC 100-240V, AC 8,4-3,5A, 50-60Hz
Maximum power consumption	840W

Software

File preparation software	BCN3D Stratos
Operating Systems	Windows, Mac, Linux
Supported files	STL, 3MF, OBJ, AMF, DAE, ZAE, CTM, PLY, X3D, GLB, GLTF
Wireless connectivity	BCN3D Cloud
Supported browsers	Google Chrome, Mozilla Firefox, Microsoft Edge, Safari, Opera

Specifications subject to change. EN-DS-EW50-v1.8

Specifications



BCN3D Smart Cabinet

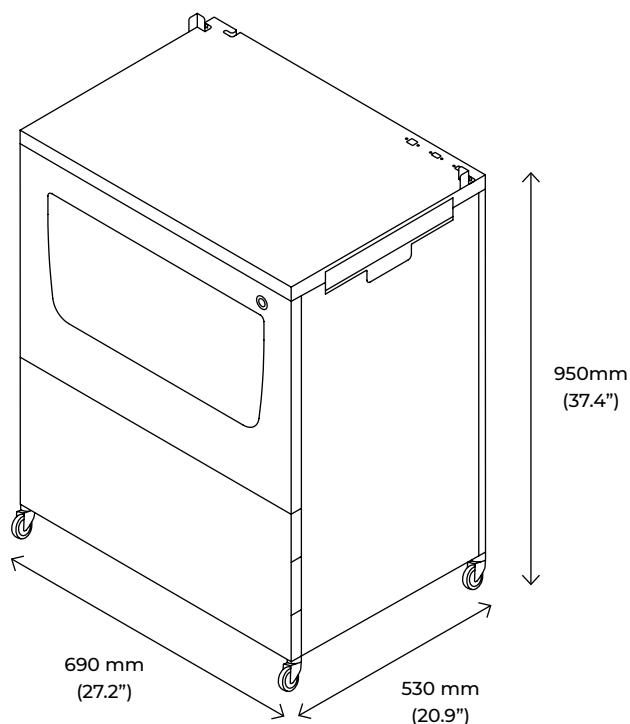
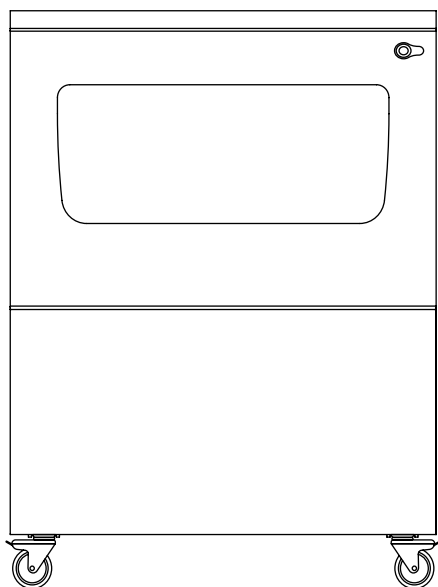

Product properties

Certifications CE / FCC

Physical properties

Overall dimensions 690mm (W) x 530mm (D) x 950mm (H)

Weight 85kg

Shipping box dimensions 800mm (W) x 600mm (D) x 1240mm (H)

Shipping weight 102kg

Shipping method Half Europallet

Specifications



BCN3D Smart Cabinet

Electrical properties

Output	230V / 120V / 100V
Input	version 230V: 200 / 208 / 220 / 230 / 240 V AC [50-60 Hz ±10Hz] version 120V: 100 / 110 / 115 / 120 / 127 V AC [50-60 Hz ±10Hz] version 100V: 100 / 110 / 115 / 120 / 127 V AC [50-60 Hz ±10Hz]
Power output	1000VA
Data connection	USB connection (Type-A to Type-B cable)
UPS topology	Online 1kVA
Battery specifications	3 batteries / 36 VDC x 7Ah
Sensors	Internal and external humidity sensor

Dehumidifier properties

Dehumidifier topology	Air tight container with an active humidity controller unit
Dehumidifier system strategy	4-cycle desiccant and recovery system: First cycle: spool drying Second cycle: stand-by Third cycle: desiccant recovery Fourth cycle: desiccant cool-down
Desiccant type	Alumina base desiccant
Humidity level	< 40% RH
Recovery time (approximate)	2h

Specifications



BCN3D Smart Cabinet

Material handling

Filament diameter	2.85mm
Compatible spools	<p>With BCN3D Spool Cartridge</p> <ul style="list-style-type: none">· Diameter: 197mm - 203mm· Central bore diameter: more than 50mm· Width: 55mm <p>Without BCN3D Spool Cartridge:</p> <ul style="list-style-type: none">· Diameter: up to 303mm· Central bore diameter: more than 50mm· Width: up to 105mm
Number of spools	<p>6 BCN3D Spool Cartridges</p> <p>10 small spools (350/500/750gr.)</p> <p>6 medium spools (1kg.)</p> <p>4 big spools (2.5kg.)</p>